



Ludington®

Under-Mount Kitchen Sink

20023-PC

Features

- Under-mount
- No faucet holes to accommodate either wall-mount or countertop faucets
- 9-7/16"-deep single bowl
- 3-3/4" drain opening
- Stainless steel with satin finish
- SilentShield technology
- 18-gauge stainless steel
- Includes contemporary silicone mat (20286-ASH) and sink strainer (7400)
- Lifetime limited warranty

Included Components

Product consists of:

- 7400 Sink Strainer
- 20284 Sink Basin Mat



Codes/Standards

ASME A112.19.3/CSA B45.4

STERLING® Warranty - Stainless Steel Sinks

See website for detailed warranty information.

1-800-STERLING (1-800-783-7546)

Kohler Co. reserves the right to make revisions without notice to product specifications.

For the most current Specification Sheet, go to www.sterlingplumbing.com.

4-25-2019 19:29 - US/CA

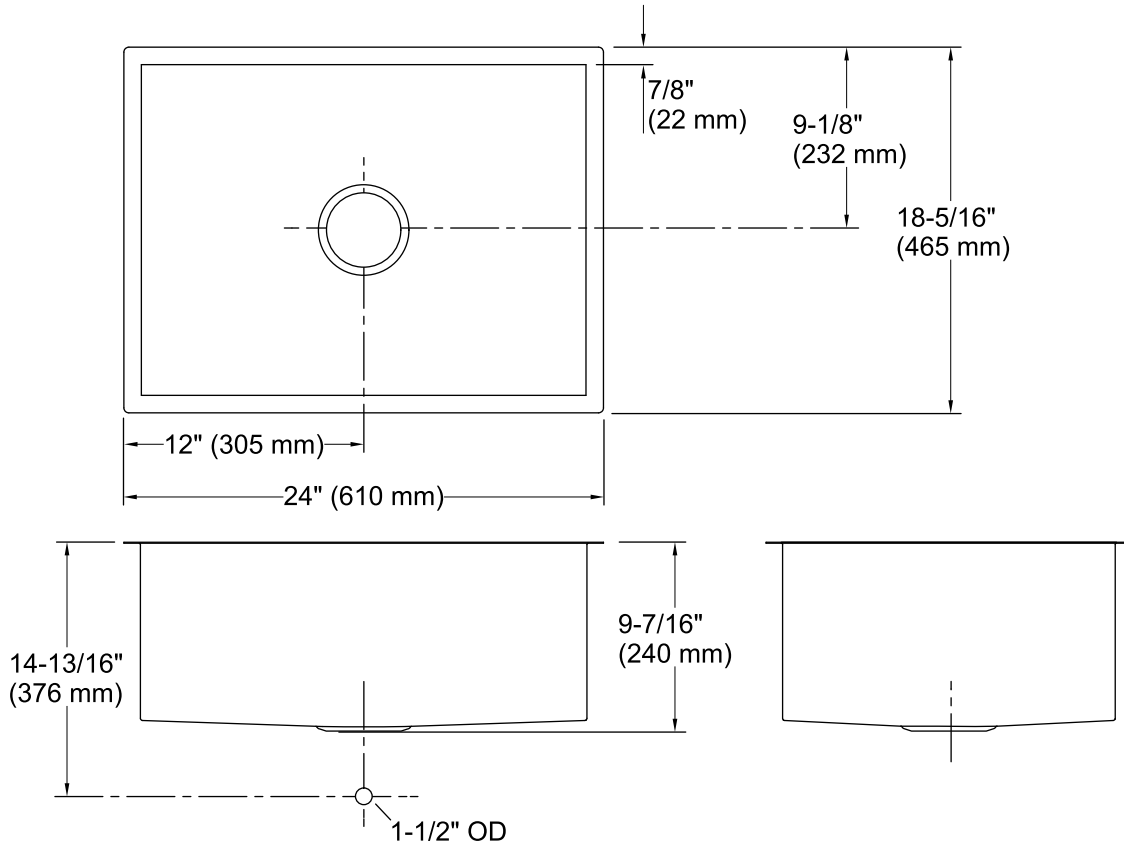

Technical Information

All product dimensions are nominal.

Installation:	Under-mount
Min. base cabinet width:	27" (686 mm)
Bowl area (Only):	Length: 22-1/4" (565 mm) Width: 16-9/16" (420 mm) Bowl depth: 9-3/16" (233 mm) Water depth: 9-3/16" (233 mm)
Drain hole:	3-3/4" (94 mm)
Template:	1298948-7, required, included

Notes

Install this product according to the installation instructions.

Countertop manufacturer or cutter must use the cut-out template provided with the product, or a current one provided by Kohler Co. (call 1-800-43-FOCUS). Kohler Co. is not responsible for cut-out errors when the incorrect cut-out template is used.