

ROHL

Authentic Luxury for Kitchen and Bath®

www.rohlhome.com



ITALIAN KITCHEN TRADITIONAL C-SPOUT HOT WATER FAUCET, TANK AND FILTER KIT

ROHL — Italian Kitchen Filtered Hot Water Dispensers

GKIT1655

FEATURES

- Complete with the following items:
 - U.1998 Hot water tank
 - G1655LM-2 Hot water faucet
 - U.1106 Hot water filter
- Instantly provides near boiling filtered water for beverages and food preparation
- Unique Anti-Scald lock: innovative push mechanism with exclusive spring-back valve
- Long lasting brass construction
- Swivel spout for ease of filling containers
- Order U.PRF1 for hot water replacement filter cartridge

COLORS/FINISHES

- Polished Chrome
- Polished Nickel
- Satin Nickel
- Matte Black*
- Italian Brass*
- Tuscan Brass**
- Unlacquered Brass**

WARRANTY

- 5-year Limited Warranty on Faucet
- 3-year Limited Warranty on Tank
- *5-year Limited Warranty in Italian Brass and Matte Black
- ** No Warranty on Tuscan Brass and Unlacquered Brass

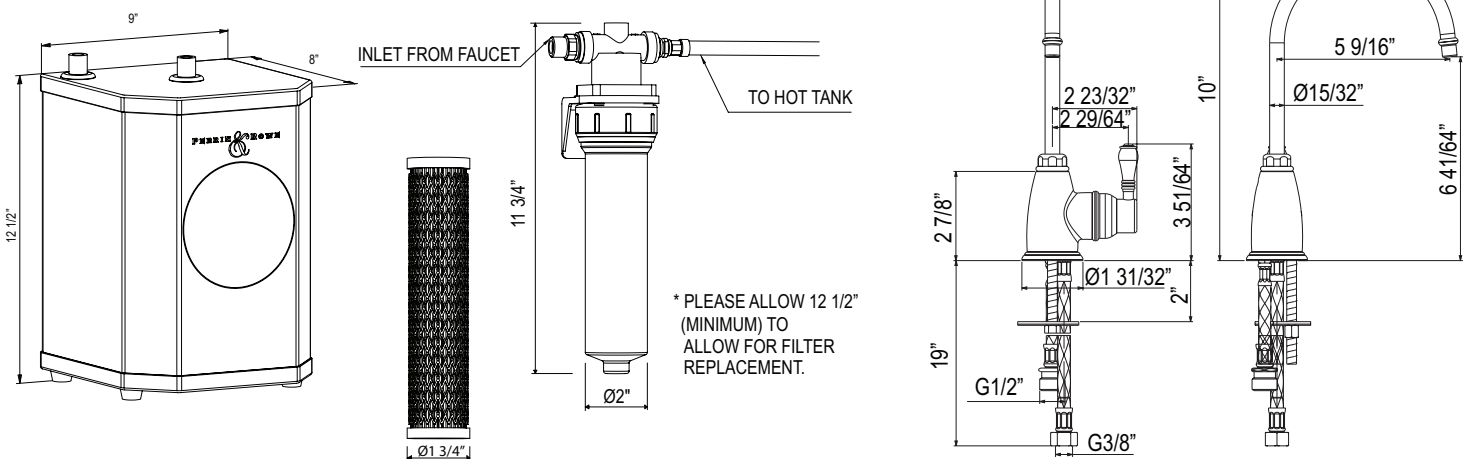

INSTALLATION INSTRUCTIONS

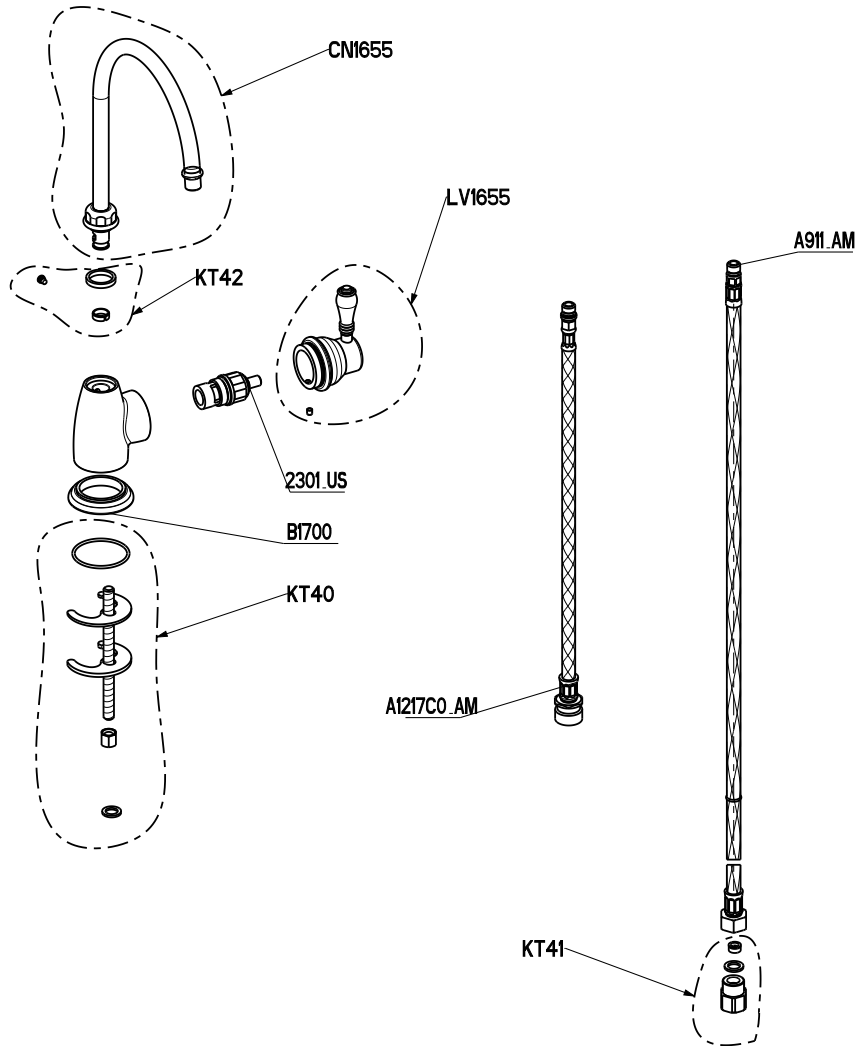

INSTALLATION INSTRUCTIONS

HOT WATER DISPENSER COLLECTION FOR USE ONLY WITH PERRIN AND ROWE HOT WATER TANK

G1445

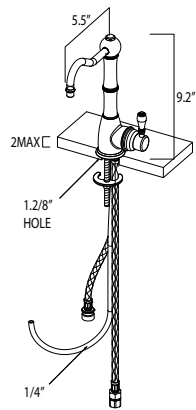

G1655

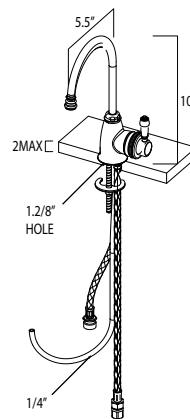

G7545

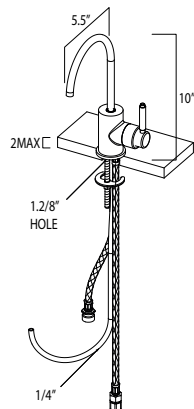

MB7945

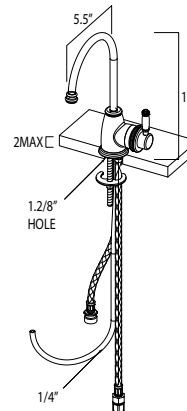

SCALDING HAZARD: The tap dispenses water up to 208.4°F (98°C), which can instantly cause scalds or burns. Use care when operating this appliance.

RECOMMENDED WORKING PRESSURE
Min 1.5bar / 22psi | Max 5bar / 75psi

INSTALLATION INSTRUCTIONS

The Hot Water Dispenser Collection

Installation & User Guide

Congratulations on the purchase of your **ROHL** product. Correctly installed and with sensible care, this product will give you many years of trouble free service.

IMPORTANT INFORMATION

Before you proceed... We recommend you engage the services of a registered plumber / builder to install this product.

Ensure you also read and understand the instruction manual that accompanies your Perrin and Rowe heater tank unit.

To avoid permanent damage to the heater tank it is important not to plug the unit until indicated in heater tank installation manual. Only operate the tank after it is filled with water.

In addition to the guide below it is essential that the written information is carefully read and understood.

Preparation Check Box for Installer

Flush the plumbing system before installing the kitchen product

Once unpacked, remove nut and clamping plate ready for installation.

1 Preparation:

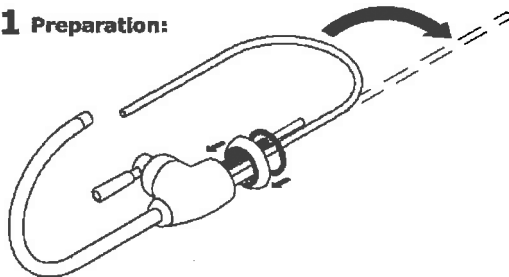

1. Unpack the hot water dispenser on a firm flat surface.
2. Carefully straighten the tubing from the bottom of the dispenser.
3. Ensure the base ring and the O seal are in place.

Attach silicone tube using the clip

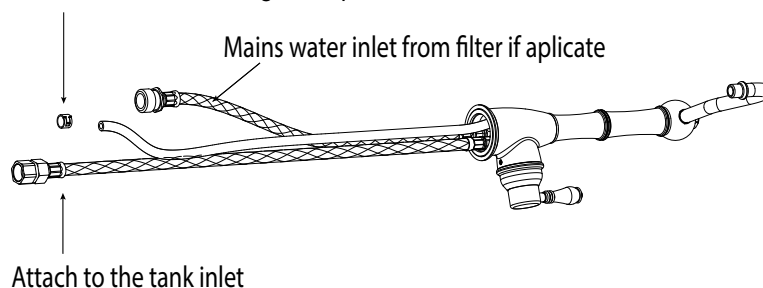

INSTALLATION INSTRUCTIONS

The Hot Water Dispenser Collection

Installation & User Guide

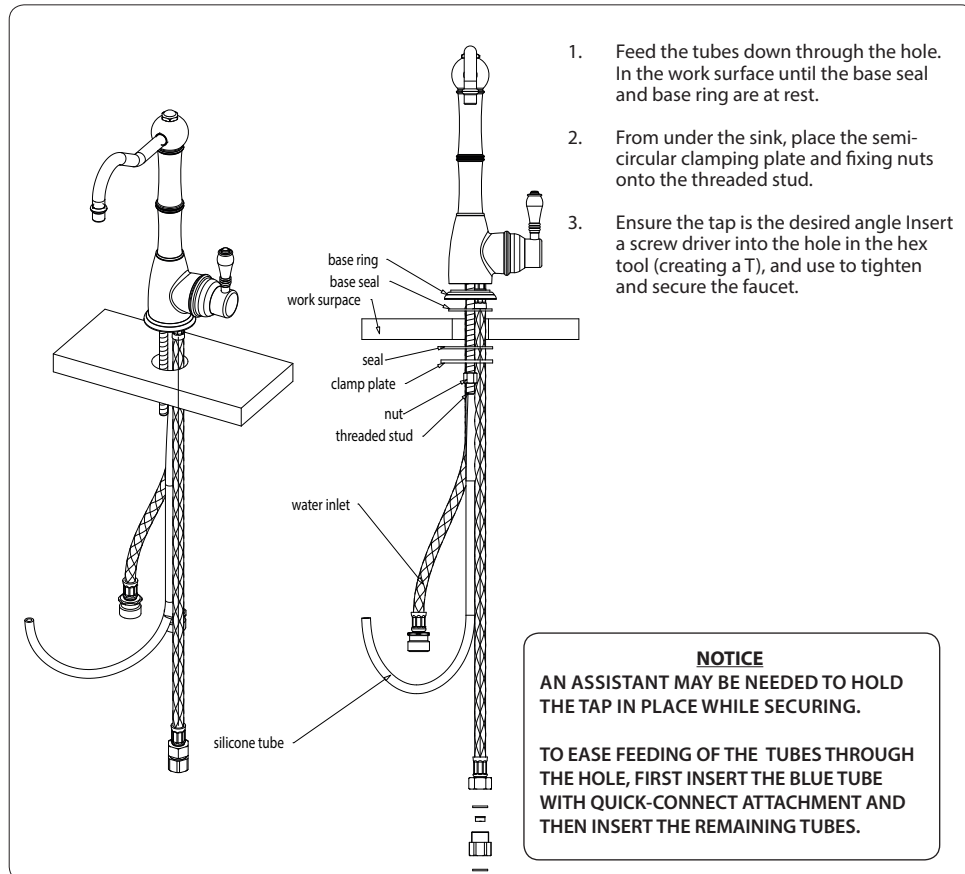

PLEASE ENSURE YOU HAVE READ & UNDERSTOOD THE PERRIN AND ROWE TANK GUIDE BEFORE USE.

BEFORE USE

- If further building work is to be carried out in the vicinity, cover the faucet to avoid damaging the finish.
- Please ensure that the installation complies with local plumbing codes.

CARE & MAINTENANCE

Wipe down after use to avoid water spotting and mineral build up.

Occasional cleaning with warm soapy water, followed by a polish with a soft cloth is all that is required to keep the plated finish in good condition.

Don't use abrasive liquids, powders, or pads to clean the shower. Don't use any products with ammonia, bleach, or limescale remover. You will damage the plated finish and void your guarantee.

ROHL

Authentic Luxury for Kitchen and Bath®

www.rohlhome.com

INSTALLATION INSTRUCTIONS

ROHL WARRANTY POLICY

Please contact the local retailer or showroom where you purchased this product for all warranty related claims.

ROHL

SPARE PARTS & SERVICE

3 Parker Irvine, California 92618-1605

Ph. 800 777 9762

Fax 714 557 8635

We would like to thank you for purchasing a **ROHL** product and take this opportunity to invite you to look at other luxury products.

Please contact us to receive our latest catalogue.

rohlinfo@rohlhome.com - www.rohlhome.com

ROHL.

Authentic Luxury for Kitchen and Bath®

www.rohlhome.com

INSTALLATION INSTRUCTIONS

PERRIN & ROWE
MAYFAIR LONDON

Electronic Instant Hot Water Appliance Installation, Operation and Care Instructions



Please read these instructions fully before commencing the installation and operation of the Electronic Instant Hot Water Appliance

INSTALLATION INSTRUCTIONS

We are delighted that you have chosen the electronic instant hot water appliance to complement your instant hot water Dispenser. This unique electronic instant hot water appliance will save you time and effort when requiring near boiling water for making tea and coffee and we are sure you will discover many new uses each day.

Please read and follow our step by step guide to the installation, operation and care for the electronic instant hot water appliance and you will soon be making that first cup of coffee or tea from your new appliance.

WHAT YOU NEED TO KNOW BEFORE YOU START

For your safety and satisfaction please read all the instructions, cautions and warnings before installing or using this electronic instant hot water appliance.

This electronic instant hot water appliance is not intended for commercial use

IMPORTANT NOTICE: This product can cause harm if installed incorrectly and should only be installed by a competent person, if you feel for any reason unsure about the installation please contact a qualified plumber or electrician to install the appliance.

Make sure all electrical wiring and connections conform to local standards.

Make sure all water connections conform to local standards.

Make sure all electrical wiring and water connections conform to local codes. Standard 120v electrical outlet is required under the sink. If possible, use a separate circuit dedicated to your Hot Tank.

The instant hot water appliance is an open vented system appliance. The water supply pressure should not exceed 72psi. If it does a pressure reducing valve must be installed.

The required water supply pressure is a minimum of 22psi to maximum of 72psi.

The water filter must be connected to the electronic instant hot water appliance and replaced every 6 months or the guarantee will be void.

Equipment Required:

Tape Measure



Adjustable Wrench



INSTALLATION INSTRUCTIONS

SAFETY INSTRUCTIONS PLEASE READ BEFORE YOU START

The alert symbols displayed on the right point to important safety information to make you aware of potential hazards that can cause serious injury or death. Please pay special attention to the information following these warning alerts. Failure to comply with these instructions could result in property damage, serious injury or death.



Please read this chapter carefully for your own safety and the safety of those around you. Please read the safety information in this instruction, installation guide and on the product, in order to install and use the product accordingly, so as to avoid any injury. The safety information will tell you what the potential danger is, how to avoid it, and identify what will happen if you do not operate following the instruction.

Electric Shock: Using an ungrounded connection or improper connection of the power supply to the product can result in a serious injury or death from electrical shock.

Electric Shock: Do not remove the earthing terminal

Do not reconstruct the plug

Do not disassemble main box and any part for the power.



Important

The instructions are only intended as a guide, if there is any doubt then please contact a certified plumber or electrician or point of purchase and avoid using the appliance until it has been checked.

COMPONENTS INCLUDED

The electronic instant hot water appliance is supplied with the following:

Electronic Instant Hot Water Appliance with USA IEC Power lead.

The water connections are to allow correct connections from the instant hot water Dispenser to the electronic instant hot water Appliance.

Outlet Connector 3/8" BSP to Silicon Tube

Inlet Connector 3/8" BSP

INSTALLATION INSTRUCTIONS

IMPORTANT SAFETY INSTRUCTIONS

PLEASE READ ALL INSTRUCTIONS CAREFULLY



When using all electrical appliances, basic safety precautions should always be followed including the information below:

To protect against electrical shock, do not place cord, plugs or unit near or in water or other liquids and do not operate the electronic instant hot water appliance controls or power socket with wet hands.

Check the power rating of your electronic instant hot water appliance is suitable for the power rating of the electrical circuit it is being installed on.

Do not operate or install the electronic instant hot water appliance if it appears to have any missing parts, be damaged / faulty eg damaged cord, plug.

Do not use outdoors or in a damp area or if below 32F. Humidity should stay in a range of 10% to 60%. Be sure there is no dew.

Do not use the electronic instant hot water appliance for anything other than the intended **Domestic** use only.

The electronic instant hot water appliance must be installed vertically as shown on front cover with inlet and outlet connections at the top of appliance.

Ensure the front of the unit is visible and the front temperature dial can be easily reached.

Do not attempt to open, modify or service this electronic instant hot water appliance. Repairs should be carried out by Authorised Service personnel. Opening the unit will void the guarantee.

The required water supply pressure is a minimum of 22psi to maximum of 72psi.

Turn off all controls before unplugging. Do not unplug by pulling the cable. To unplug, grasp the plug, not the cable.

Property Damage: To avoid the risk of flooding, regularly inspect the connections for any signs of leakage.

This electronic instant water appliance is not intended for use by persons (including children) with reduced physical, sensory or mental capabilities, or lack of experience and knowledge, unless they have been given supervision or instruction concerning use of the appliance by a person responsible for their safety. Children should be supervised to ensure that they do not play with the electronic instant hot water appliance or instant hot water Dispenser, a safety springback handle is used to control the flow of the near boiling water for additional safety.

INSTALLATION INSTRUCTIONS

INSTALLATION REQUIREMENTS

Electrical Requirements



A standard 120v electrical outlet is required under the sink. If possible, use a separate circuit dedicated to your Hot Tank. It is recommended that a separate circuit serving only your electronic instant hot water appliance be provided or use an outlet that can be turned on/off by a switch. This electronic instant hot water appliance is equipped with a power supply cord with a power plug. To minimise possible shock hazard, the cord must be plugged into mating, ground-type outlet, grounded in accordance with all national and local codes and ordinances. If a socket outlet is not available, it is the responsibility and obligation of the customer to have a properly grounded outlet installed by a qualified electrician.

Water Supply Requirements



If local codes permit, the instant hot water Dispenser feed line should be connected to the hot and cold water supply line using an isolation valve or another means for providing the hot and cold water to the Dispenser. IMPORTANT: If local codes do not permit the use of isolation valves, special feed valves can be obtained from your local plumbing supply distributor. If the water is mixed with impurity, ironing chips, grains of sand, and so on, the pipes of the electronic instant hot water appliance and Dispenser will be blocked and will void the guarantee.

Environment requirement



Don't install the electronic instant hot water appliance outdoors or in a location that may fall below 32F, otherwise the pipes and the Dispenser and tank will be frozen and there will be serious safety trouble, possible bodily-injury, accidents and damaged caused and the guarantee will be void. It's forbidden to wash the electronic instant hot water appliance with water directly. The installation environment should be ventilated, with protection from the direct sunshine. When installing the electronic instant hot water appliance, provide approximately 10cm to 15cm (4 - 5 ½") of air space on the sides of the unit for air circulation and approximately 2.5cm (1") from the mounting wall. The environment humidity should be in the range of 10% to 60%. Be sure there is no dew.

Instant Hot Water Dispenser Information



Connecting a standard Dispenser may cause injury and will damage the electronic instant hot water appliance and void the guarantee. Due to high water temperature, and for safety reasons, the electronic instant hot water appliance is not under pressure.

Instant Hot Water Appliance Temperature Adjustment



For temperatures above 203F:- it has been set for optimum performance in most common and typical known installations. However there are factors which may influence the performance of the instant hot water appliance such as incoming water temperature, atmospheric pressure and altitude. Should you experience any discharge of water from the spout during heat up, you can reduce the setting to compensate for this by 3F degrees at a time. If in doubt please ask your dealer for further guidance.

INSTALLATION INSTRUCTIONS

PREPERATION FOR INSTALLATION

Unlike other household hot water appliances, this electronic instant hot water appliance is Non Pressurised for safety reasons. For this electronic instant hot water appliance, the **Instant Hot Dispenser** is placed before the electronic instant hot water appliance, creating an “open vent” system and consequently no pressure is built up inside the appliance.

⚠ WARNING

IMPORTANT: Install the Instant Hot Water Dispenser in accordance with the fitting Instructions provided with the Hot Water Dispenser.

⚠ WARNING

Preparation for the electronic instant hot water appliance installation
IMPORTANT: Observe all local governing codes and ordinances.

The electronic instant hot water appliance must be mounted vertically and level. Before you begin, select a proper location ideally directly under the instant hot water Dispenser or close to it to ensure the connection pipes will connect from the instant hot water Dispenser to the electronic instant hot water appliance.

The electronic instant hot water appliance is not under pressure, consequently, there is a slight delay in water flow after the hot water springback Dispenser handle has been turned on. This is normal and indicates that the electronic instant hot water appliance is functioning properly.

It is recommended that you have access to a separate power circuit serving only your electronic instant hot water appliance. See previous pages for more information on “ELECTRICAL REQUIREMENTS”.

INSTALLATION

Step 1– Position the Instant Hot Water Appliance **⚠ WARNING**

Ensure the electronic instant hot water appliance is **NOT** connected to the Electric Power during installation.

Place the electronic instant hot water appliance in position and check to ensure that the instant hot water Dispenser connection pipes and the power cord will reach without being stretched.

The electronic instant hot water appliance must be positioned so the tubes from and to the instant hot water Dispenser do not twist or kink.

INSTALLATION INSTRUCTIONS

INSTALLATION CONTINUED

Step 2 – Connect Dispenser

The electronic instant hot water appliance inlet connection is a 3/8" BSP male threaded connector. The outlet connector is a 3/8" BSP male thread connector.

Check the connections type and size on the instant hot water Dispenser for the inlet and outlet connections.

Screw on the inlet and outlet pipe the correct connectors and tighten with a wrench.

Connect the cold and hot Dispenser inlet hoses to the mains in the normal way. Fitting a pressure reducing valve to the cold mains inlet if the mains pressure is above 5bar. Tighten with a wrench and move to check the complete installation for leaks.

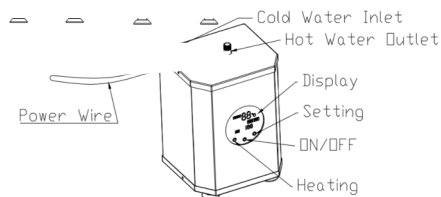

Step 3 – Priming and Checking for Water Tightness

Before the electronic instant hot water appliance is plugged into the power socket it must be tested for water tightness and no leaks.

Open all water valves to allow water to flow to the instant hot water Dispenser.

Turn the spring back instant hot water handle and hold to fill the electronic instant hot water appliance this will take about 90 seconds.

⚠ WARNING
⚠ DANGER When the electronic instant hot water appliance is full, water will flow from the instant hot water Dispenser spout. Initially as air is purged the out let may spit or splutter. To remove air from the system continue to operate the lever for 1-2 gallons or more if needed. Turn the instant hot water handle off and check all connections for water tightness and leaks.

Any leaking joint must be tightened to ensure no water leakage and the above priming undertaken again and checked for water tightness before connecting to the power socket.

INSTALLATION INSTRUCTIONS

INSTALLATION CONTINUED

Step 4 – Electrical Connection

Ensure that the installation area is dry and no water has spilled.

Connect the plug to the power socket and turn on the power socket at the switch.

The electronic instant hot water appliance display panel will now light up with the on / off button illuminated.



Step 5 –Electronic Instant Hot Water Appliance Operation



Electronic Control Display Panel



ON/OFF to control the power it will also control the display ON/OFF.





Confirmation and heating control switch



Temperature setting, 7 temperature settings: 208°F max. 206°F; 203°F; 194°F;185°F' 176°F; 167°F

To turn on the electronic instant hot water appliance touch the  button and hold for 3 seconds until the display lights up.

Touch the  button and press each time so that the temperature settings will change from 167°F to 176°F to 194°F to 185°F to 194°F to 203°F to 206°F to 208°F continue to press till the required temperature is seen.To confirm the temperature and start the elec-

tronic instant hot water appliance press the  button and the electronic instant hot water appliance will start to heat up the water and an audible beep will be heard.

INSTALLATION INSTRUCTIONS

MAINTENANCE AND CARE INSTRUCTIONS CONTINUED

Flushing the Instant Hot Water Tank



It is recommended that the user flushes through the system completely by drawing off the instant hot water and allowing to reheat and repeating the process for a further 2 or 3 times to ensure the system is fully operational.

Water Draw Back and Contamination in the Tank



During the filling of any vessel the user must ensure at all times that the spout outlet is not submerged in the water during the dispensing of the instant hot water and especially when the instant hot water handle is released.

Maintenance & Power Saving

If the electronic instant hot water appliance is not being used for long periods of time ie: over 2 days, to save power we recommend you switch off using the "ON/OFF" switch.

Seasonal Shutdown

The hot water system (tank and Dispenser) must not be exposed to freezing temperatures. If there is a possibility of this the system must be drained of water. Shut-off the mains supply and unplug the unit from the electricity mains and allow the tank to cool for at least 1 hour. Disconnect the inlet supply to the tank and remove the silicone hose outlet pipe, lift the unit to the sink, turn upside down and drain all the water from the tank. When re-installing follow the original installation instructions.

NOTICE

The electronic instant hot water appliance like any water heater has a limited operational life span and will eventually fail. In order to ensure maximum protection and to avoid possible damage to any property or personal injury the electronic instant hot water appliance should be inspected regularly for any water leakage or damage.

Regularly check for any signs of water leakage, if there is any water leakage then replace any loose or split silicon tubes or flexi tails which can cause water leakage and damage.

To provide additional water security to avoid property damage the electronic instant hot water appliance can be placed in a drain pan and connected to a suitable drain outlet to avoid any water damage. The drain pan should be installed using the manufacturers installation instructions.

INSTALLATION INSTRUCTIONS

TROUBLE SHOOTING

PROBLEM	POSSIBLE CAUSE	WHAT TO DO
Water and Steam is spitting from the instant hot water Dispenser spout	Unit is boiling	<p>Turn instant hot water Dispenser handle on and release at least 1 pint of water.</p> <p>Adjust the water temperature on the display to a lower setting.</p> <p>Check aerator is not blocked</p> <p>Bleed system to remove any air</p> <p>Re-Prime bladder to allow correct operation.</p>
Water is not hot.	<p>The electronic instant hot water appliance is unplugged.</p> <p>The electronic display has not been powered up</p>	<p>Make sure the electronic instant hot water appliance is plugged in and connected to a grounded electric outlet</p> <p>Make sure that the circuit breaker and fuse are working correctly</p> <p>Turn on the power and touch the on / off button and then set the required temperature and confirm the heat up.</p>
Water is too hot.	Water temperature setting on display panel is set to high.	Re-set the temperature to the required temperature and confirm the heating up
Water is dripping from the instant hot water Dispenser spout.	<p>The expansion chamber isn't draining the system correctly due to very small draw off of water</p> <p>The spout is blocked</p>	<p>Draw off 1 pint of water to clear and prime the system. Avoid less than 1/3 of a pint draw offs of water. Remove and clean the aerator.</p> <p>Check silicon pipe length.</p>

INSTALLATION INSTRUCTIONS

TROUBLE SHOOTING CONTINUED

PROBLEM	POSSIBLE CAUSE	WHAT TO DO
Slow Flow from the spout	Water Filter may be clogged from impurities in the inlet mains water	The water filter must be changed every 6 months or this will void the guarantee
Water does not flow straight away	The electronic instant hot water appliance is design for non-pressurised operation and there will be slight delay till the near boiling water appears	After a large volume of water has been drawn off there may a slightly longer delay in the water appearing from the instant hot water Dispenser spout. Check length of silicon pipe.
No Water Flowing	Water Valves have been turned off Inlet Pipes have been twisted or blocked	Turn on all the water valves Ensure the pipes are not twisted or kinked to restrict flow Remove and clean the aerator

IF YOU ARE IN ANY DOUBT THEN POWER OFF THE ELECTRONIC INSTANT HOT WATER APPLIANCE AND CALL THE SERVICE AGENT

ROHL

Authentic Luxury for Kitchen and Bath®

www.rohlhome.com

INSTALLATION INSTRUCTIONS

PERRIN & ROWE
MAYFAIR LONDON



Customer Services :

ROHL LLC

3 Parker

Irvine, California

92618-1605

Phone 800-777-9762

www.rohlhome.com

Guarantee Void Unless The Water Filter Is Replaced Every 6 Months

Issue : PRV114112017

Rohl & Perrin & Rowe are Registered trade marks.

ROHL
Authentic Luxury for Kitchen and Bath™



INSTALLATION INSTRUCTIONS

• INSTANT HOT TAP •



• CARTRIDGE REPLACEMENT

THE FILTER CARTRIDGE IN YOUR INSTANT HOT TAP SYSTEM NEEDS TO BE CHANGED EVERY SIX MONTHS IN ORDER TO ENSURE THE SYSTEM WORKS AT ITS OPTIMUM PERFORMANCE.

CHANGING THE FILTER CARTRIDGE IS A SIMPLE MATTER:

1. SWITCH OFF THE HEATER TANK EITHER AT THE MAINS OR BY PRESSING THE CENTRE BUTTON ON THE HEATER TANK TOUCH SCREEN.
*****IMPORTANT NOTICE*** – RUN OFF ALL HOT WATER UNTIL JUST COLD WATER IS COMING OUT OF THE TAP.**
2. PLACE A SMALL BOWL UNDER THE FILTER HOUSING SUMP TO CATCH THE SMALL AMOUNT OF WATER THAT WILL BE RELEASED WHEN REMOVING THE FILTER HOUSING SUMP.
3. TURN THE FILTER HOUSING SUMP ANTI-CLOCKWISE A QUARTER TURN, TO ALLOW THE FILTER HOUSING SUMP TO DROP DOWN FROM THE FILTER HOUSING HEAD.
4. ONCE THE SUMP IS REMOVED, UNSCREW THE FILTER HOUSING CAP FROM THE SUMP AND TIP ANY WATER OUT OF THE SUMP INTO THE BOWL OR SINK.
5. REMOVE THE OLD FILTER BY PULLING THE FILTER FROM THE CAP.
6. DISPOSE OF THE OLD FILTER IN THE NORMAL HOUSEHOLD WASTE BIN.
REMEMBERING TO KEEP THE FILTER INSERT AS YOU WILL NEED THIS FOR THE REPLACEMENT FILTER.
7. FIT THE NEW FILTER BY PUSHING THE FILTER INSERT INTO THE TOP OF THE FILTER THEN INTO THE CAP; YOU MAY NEED TO WET THE 'O' SEALS IN THE TOP OF THE FILTER AS SHOWN IN THE ATTACHED DRAWING REFERENCED A. ALWAYS INSPECT THE 'O' SEALS FOR DAMAGE; FOR REPLACEMENTS USE CONTACT DETAILS BELOW.
8. SCREW THE SUMP BACK ONTO THE CAP (ENSURING THAT THE 'O' SEAL IS IN PLACE), REFERENCED B.
9. PUSH THE FILTER HOUSING SUMP BACK INTO THE FILTER HOUSING HEAD AND TURN CLOCKWISE UNTIL IT STOPS.

IMPORTANT NOTICE

THE FILTER IS NOW READY TO USE – IT IS VITALLY IMPORTANT THAT YOU FOLLOW THE PROCESS BELOW TO ENSURE THAT ALL AIR IS BLED FROM THE SYSTEM. **PLACE A JUG UNDER THE SPOUT AS WATER WILL SPLUTTER FROM THE SPOUT UNTIL ALL OF THE AIR IS EXPELLED.**

OPERATE THE INSTANT HOT TAP LEVER TO DISPENSE WATER, RUN-OFF AT LEAST 0.35 GALLONS OF WATER, LET THE SYSTEM REST FOR AT LEAST 30 SECONDS AND RUN ANOTHER 0.35 GALLONS OF WATER, REPEAT THIS AT LEAST ONE MORE TIME – YOUR INSTANT HOT WATER TAP SHOULD NOW BE READY FOR USE.

YOU MUST NOW THOROUGHLY CHECK THE UNIT FOR ANY WATER LEAKS AND TAKE THIS OPPORTUNITY TO CHECK FOR ANY EXCESS WEAR OR DAMAGE TO THE SYSTEM. IF THERE ARE NO LEAKS PLEASE CONTINUE:

10. NOW SWITCH THE HEATER TANK BACK ON AT THE MAINS, OR BY PRESSING THE BUTTON IN THE CENTRE OF THE HEATER TANK TOUCH SCREEN.
11. SET THE DESIRED TEMPERATURE BY PRESSING THE RIGHT HAND BUTTON UNTIL THE DESIRED TEMPERATURE IS DISPLAYED (USUALLY 98 DEGREES)
12. PRESS THE LEFT HAND BUTTON TO CONFIRM THE TEMPERATURE SETTING.
13. THE HEATER TANK WILL NOW HEAT UP TO THE DESIRED TEMPERATURE AND ONCE COMPLETED THE SYSTEM IS READY FOR USE.

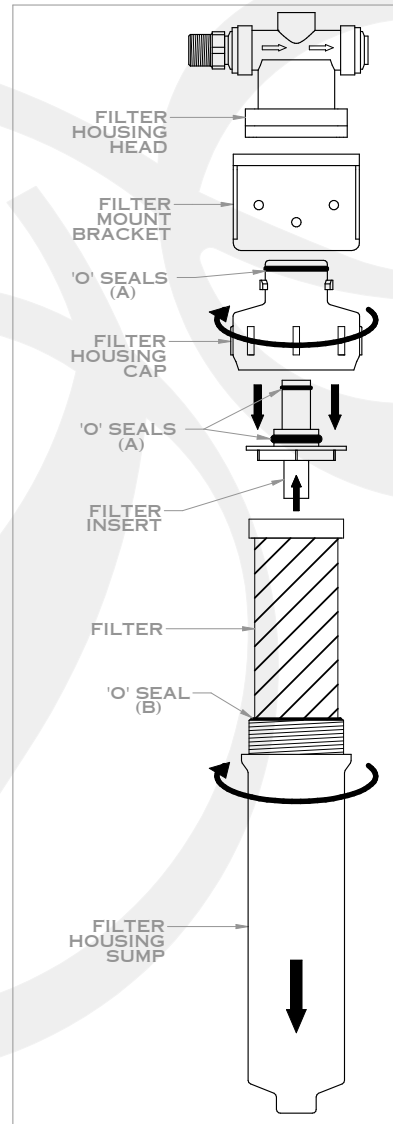

INSTALLATION INSTRUCTIONS

• INSTANT HOT TAP •

PERRIN & ROWE®
MAYFAIR & LONDON

• FILTER INSTALLATION

1. FIXING MOUNTING BRACKET

IT IS VERY IMPORTANT THAT BEFORE YOU START INSTALLING THIS FILTER SYSTEM YOU ENSURE YOU HAVE READ THE INSTALL GUIDES THAT CAME WITH THE TAP AND THE HEATER TANK.

FIRST YOU WILL NEED TO REMOVE THE FILTER SUMP. THIS CAN BE DONE BY TURNING THE SUMP A QUARTER TURN ANTI-CLOCKWISE AND PULLING DOWN.

FIX THE FILTER MOUNTING BRACKET TO THE INSIDE OF THE CUPBOARD WITH THE SCREWS PROVIDED, USING THE BRACKET AS A TEMPLATE FOR DRILLING THE HOLES. ALTERNATIVELY MAKE USE OF THE SUPPLIED ADHESIVE PAD, ENSURING THE MOUNTING AREA IS CLEAN BY USING THE WIPE PROVIDED.

MAKING SURE:

- THERE IS ENOUGH ROOM UNDERNEATH THE FILTER HOUSING FOR FILTER REPLACEMENT AND MAINTENANCE.
- THE HOUSING IS CLOSE ENOUGH TO THE HEATER TANK & TAP SO THAT HOSES ARE NOT OVER STRETCHED.
- THE HOUSING IS ACCESSIBLE FOR FUTURE MAINTENANCE & FILTER REPLACEMENT.

2. ATTACHING HOSES

**** MAKE SURE ALL HOSES ARE FREE OF KINKS ****

ATTACH THE G3/8" BRAIDED HOSE FROM THE TAP TO THE THREADED SIDE OF THE FILTER HOUSING.

ATTACH THE THREADED END OF THE PUSH-FIT BRAIDED HOSE TO THE TOP OF THE HEATER TANK AS SHOWN BELOW.

RE-FIT THE FILTER SUMP TO THE MOUNTING BRACKET.

PLEASE NOW THOROUGHLY CHECK THE UNIT FOR ANY WATER LEAKS BEFORE YOU CONTINUE.

3. SYSTEM LAYOUT

IMPORTANT NOTICE

THE FILTER IS NEARLY READY TO USE - IT IS VITALLY IMPORTANT THAT YOU ENSURE THAT ALL AIR IS BLED FROM THE SYSTEM. DO THIS BY:

PLACE A JUG UNDER THE SPOUT AS WATER WILL SPLUTTER FROM THE SPOUT UNTIL ALL OF THE AIR IS EXPELLED.

OPERATE THE INSTANT HOT TAP LEVER TO DISPENSE WATER, RUN-OFF AT LEAST 0.35 GALLONS OF WATER, LET THE SYSTEM REST FOR AT LEAST 30 SECONDS AND RUN ANOTHER 0.35 GALLONS LITRES OF WATER, REPEAT AT LEAST ONE MORE TIME - YOUR INSTANT HOT WATER TAP SHOULD NOW BE READY FOR USE.