

Tools Required

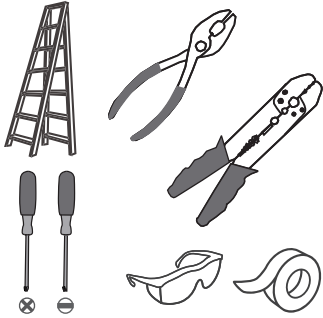

Light Source

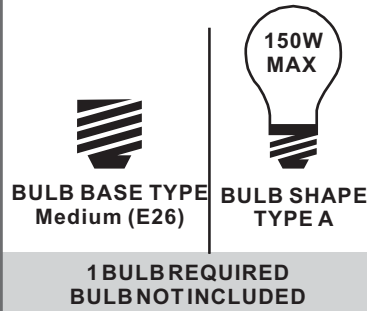

Warnings and Cautions

Turn off the electricity at the circuit breaker before installation. Consult a licensed electrician if in doubt about installation.

Turn off power to the fixture and allow the bulbs to cool before replacing.

Package Contents

Preparation: Identify and inspect all parts before beginning the installation.

Missing or damaged parts? Contact your original place of purchase.

PARTS BAG

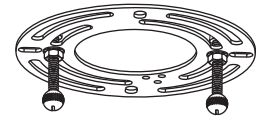

A Crossbar Assembly x 1



B Alternate Mounting Screw x 2



C Outlet Box Screw x 2



D Wire Connector x 3

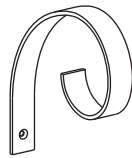

E Scroll x 1



F Lock Screw x 1



G Socket Collar x 1

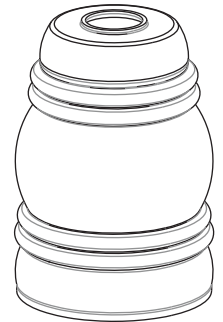

H Glass x 1

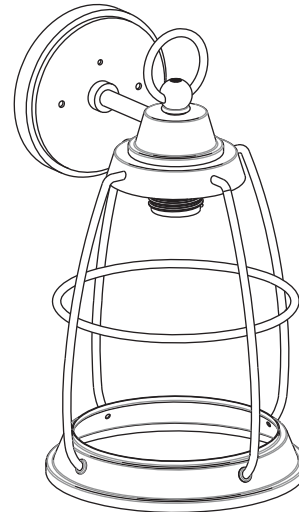

I Fixture Body x 1

Table of Contents

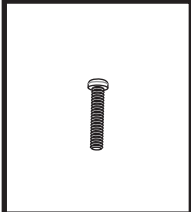
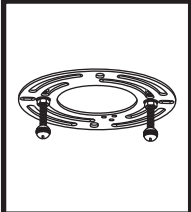
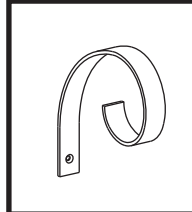
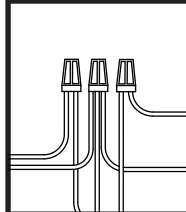
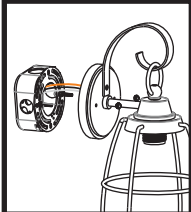
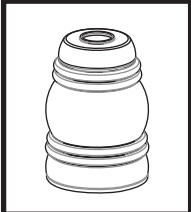
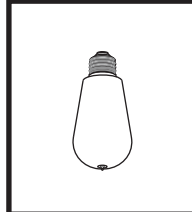
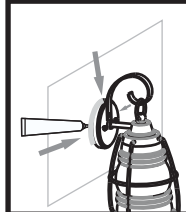
Alternate Mounting Screw	Crossbar Assembly	Scroll	Wiring
			
STEP 1	STEP 2	STEP 3	STEP 4
			
STEP 5	STEP 6	STEP 7	STEP 8
Fixture Body	Glass	Bulb	Caulk

STEP 1

OPTION 1

Standard Mounting Screw
Included (Pre-assembled)



OPTION 2

Alternate Mounting Screw
Included



skip to next page

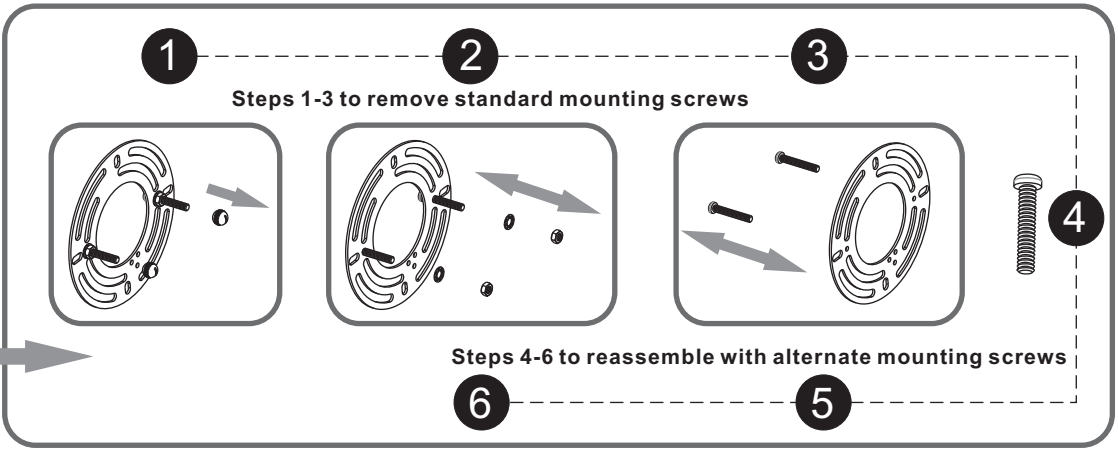

STEP 2

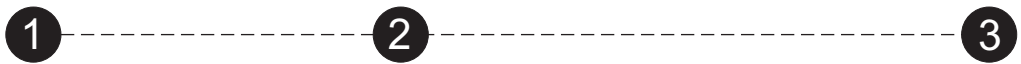

Step 1
Install crossbar assembly

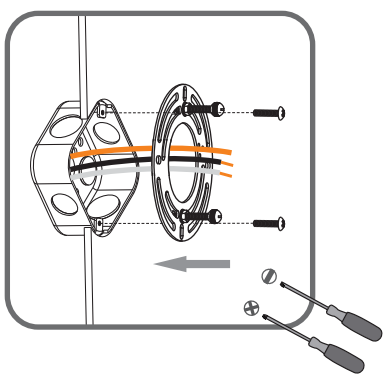

Step 2 - 3
Test fitting backplate to mounting screws

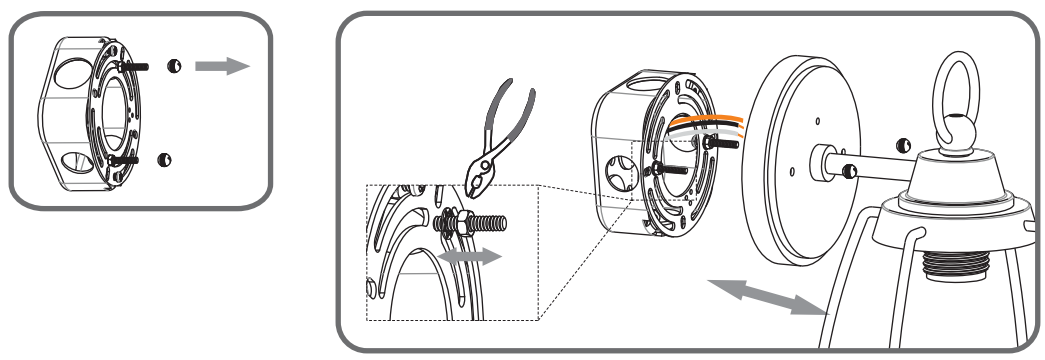

STEP 3

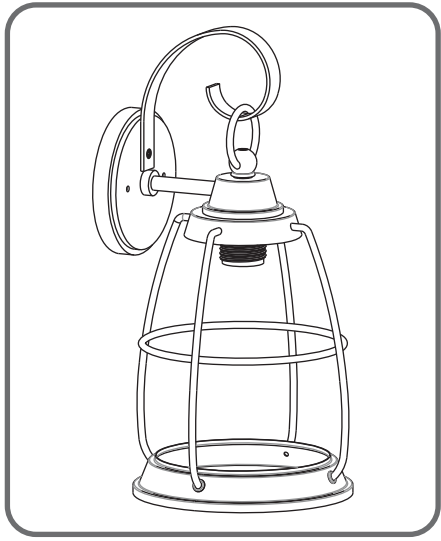
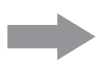
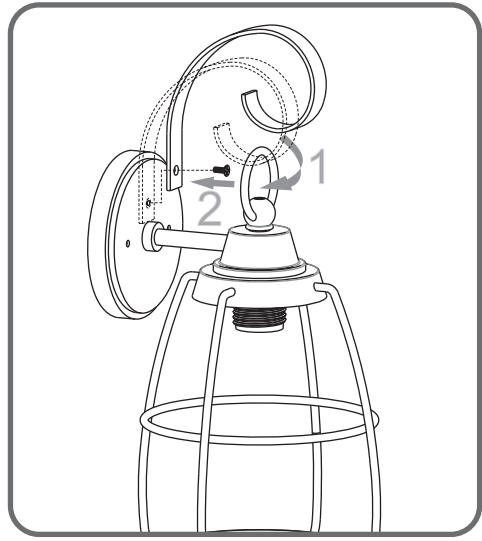

STEP 4

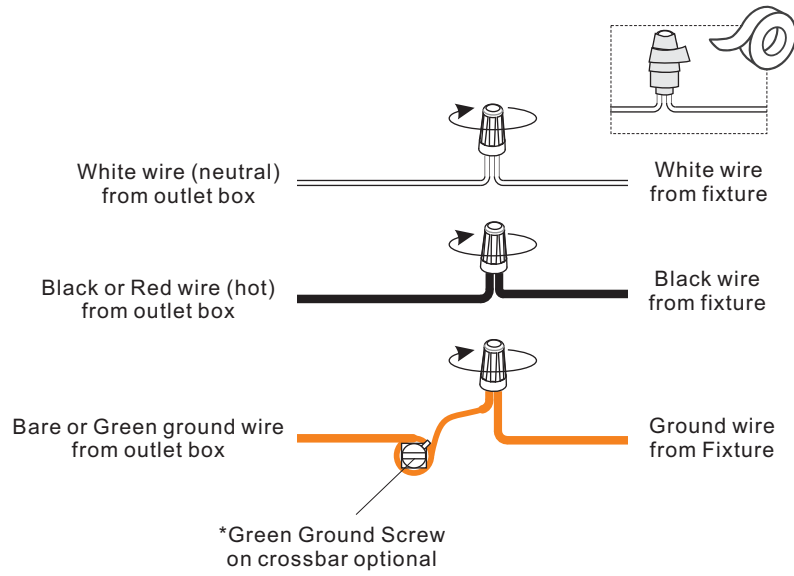

STEP 5

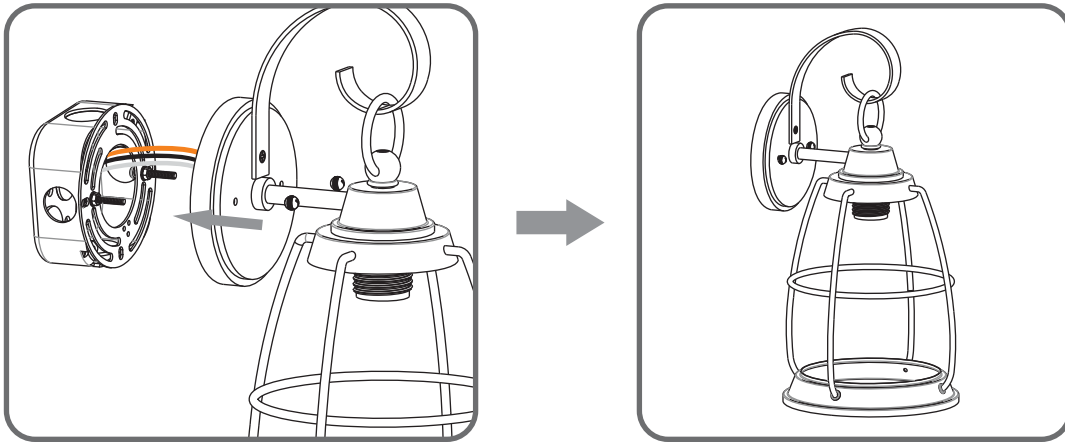

STEP 6

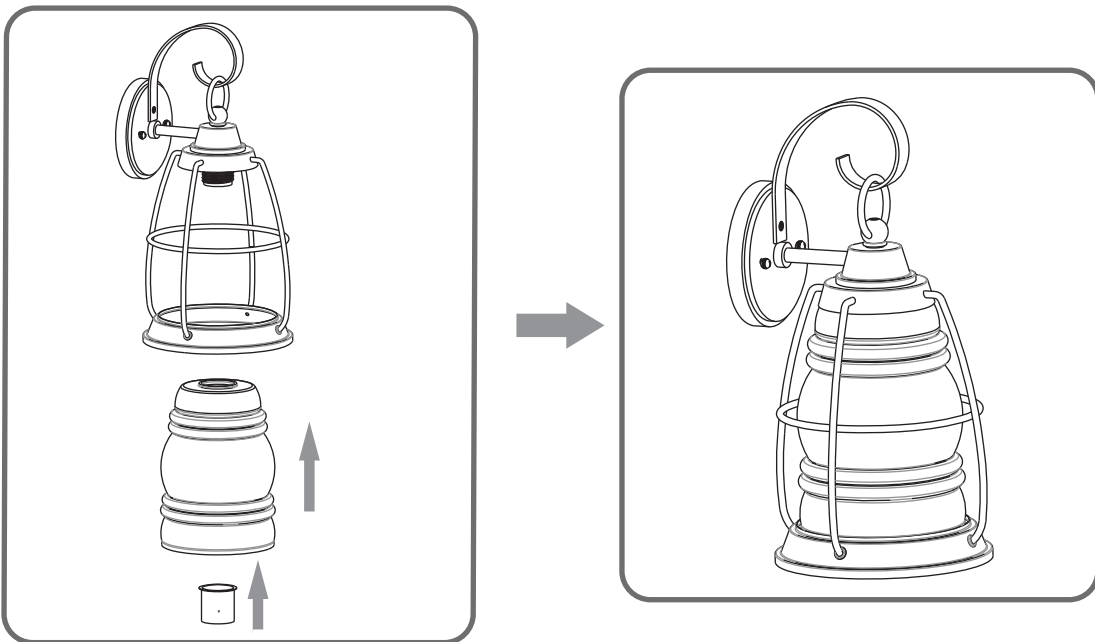

STEP 7

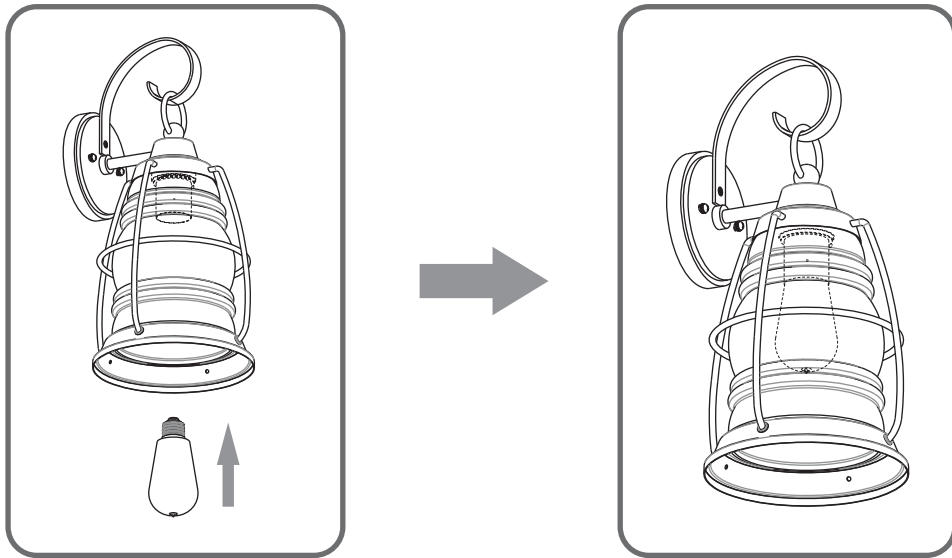

STEP 8

