

# NIO-4SNDC

4" Iolite Square Reflector with Round Aperture with 10° Optic

Source: 12W  
850lm

## PRODUCT DESCRIPTION

4" Iolite luminaires can be specified for use with Iolite new construction or remodel housings. Deep regressed cone reflectors optimize visual cut-off.

## FEATURES

- Delivering up to 8392 center beam candlepower (CBCP)
- 2700K, 3000K, 3500K, 4000K @ 90+ CRI
- 10° TIR optic delivers luminous intensity of higher lumen downlights
- 5-Year limited warranty

## SPECIFICATION

**Construction:** Trims are constructed of heat dissipating, die-cast aluminum. The aluminum die-cast LED heat sink is threaded to fit the reflector and transfer heat.

**Mounting:** Trim includes friction blades to mount securely to housing.

## OPTIC

Each luminaire includes 10° TIR optic (Note: cannot be changed in the field)  
Luminaire is also available with field changeable optics, [Click Here](#) for more information.

## ELECTRICAL

**Lumens / Wattage:** 850lm / 12W  
**Color Temperature:** 2700K, 3000K, 3500K, 4000K  
**Color Rendering Index:** 90+CRI  
**Operating Temperature:** Specified by housing  
**Lifetime:** 50,000 hours @ L70  
**Dimming:** Specified by housing

## COMPATIBLE HOUSINGS

Luminaires are compatible with respective Iolite housings manufactured by Nora Lighting.

CATALOG NO.	DESCRIPTION
<a href="#">NHIOICD-48LE4</a>	ICAT New Construction, 120-277V; Triac / ELV / 0-10V
<a href="#">NHIOICD-48LUPEQ</a>	ICAT New Construction, 120/277V; Lutron EcoSystem
<a href="#">NHIOICDCP-48LE4</a>	Chicago Plenum, 120-277V; Triac / ELV / 0-10V
<a href="#">NHIOICDCP-48LUPEQ</a>	Chicago Plenum, 120/277V; Lutron EcoSystem
<a href="#">NHRIOIC-48LE4</a>	ICAT Remodel, 120-277V; Triac / ELV / 0-10V

**Accessories:** Luminaires can accommodate (1) hex louver and (1) translucent deco collar or opaque snoot, no accessory holder is required, see accessories page. Flush mount mud ring is available to give the appearance of a trimless, compatible with new construction housing only.

## LABELS AND LISTINGS

- cULus Listed for Wet Locations
- ENERGY STAR certified
- [5-Year Limited Warranty](#)
- RoHS Compliant
- Certified to the high efficacy requirements of California Title 24 JA8-2019



Type

Project

Catalog No.

Notes

## Performance Data

Part Number	Lumens	CCT	CBCP
<b>NIO-4SNDC40QWW</b>	884lm	4000K	8392 cd

*Delivered lumens will vary depending on CCT and finish*

## PRODUCT IMAGES & DIMENSIONS

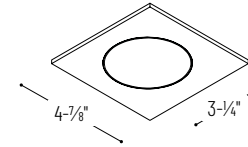

**NIO-4SNDC**  
Square Reflector with Round Aperture  
Non-Adjustable

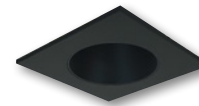

**BB**  
Black Reflector  
Black Flange

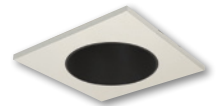

**BW**  
Black Reflector  
White Flange

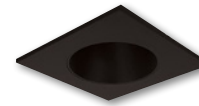

**BZ**  
Bronze Reflector  
Bronze Flange

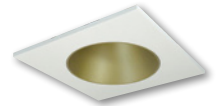

**CHMPW**  
Champagne Haze Reflector  
Matte Powder White Flange



**CMPW**  
Specular Clear Reflector  
Matte Powder White Flange



**HW**  
Haze Reflector  
White Flange



**HZMPW**  
Haze Reflector  
Matte Powder White Flange



**MPW**  
Matte Powder White Reflector  
Matte Powder White Flange



**NN**  
Natural Metal Reflector  
Natural Metal Flange



**WW**  
White Reflector  
White Flange

## 4" Iolite Square Reflector with Round Aperture and 10° Optic - Dedicated Housing Required

Type	Color Temperature	Finish
<b>NIO-4RND</b> = Round Reflector	<b>270</b> = 2700K	<b>BB</b> = Black / Black
	<b>300</b> = 3000K	<b>BW</b> = Black / White
	<b>350</b> = 3500K	<b>BZ</b> = Bronze / Bronze
	<b>400</b> = 4000K	<b>CHMPW</b> = Champagne / Matte Powder White <b>CMPW</b> = Specular Clear / Matte Powder White <b>HW</b> = Haze / White <b>HZMPW</b> = Haze / Matte Powder White <b>MPW</b> = Matte Powder White <b>NN</b> = Natural Metal / Natural Metal <b>WW</b> = White / White

## Compatible Housings

Housing Type
<b>NHIOICD-48</b> = ICAT New Construction / 800-1000lm / 14W
<b>NHIOICDCP-48</b> = Chicago Plenum / 800-1000lm / 14W
<b>NHRIOIC-48</b> = ICAT Remodel / 800-1000lm / 14W
<b>NHIOICD-415</b> = ICAT New Construction / 1500lm / 20W
<b>NHIOICDCP-415</b> = Chicago Plenum / 1500lm / 20W
<b>NHIOICD-420</b> = ICAT New Construction / 2000lm / 24W
<b>NHIOICDCP-420</b> = Chicago Plenum / 2000lm / 24W
<b>NHIOICD-425</b> = ICAT New Construction / 2500lm / 28W
<b>NHIOICDCP-425</b> = Chicago Plenum / 2500lm / 28W

Example: **NIO-4SNDC40QWW** = 4" Iolite Square Reflector with Round Aperture and 10° Optic, 4000K, White finish

# 4" Iolite Accessories

## 4" Iolite Square Reflector with Round Aperture with 10° Optic

Type
Project
Catalog No.
Notes

### ACCESSORIES

Iolite accessories can be added at any point in the design process. Accessories easily install between LED module and die-cast trim. Luminaire will accommodate (1) hex louver and (1) collar accessory, no accessory holder required.

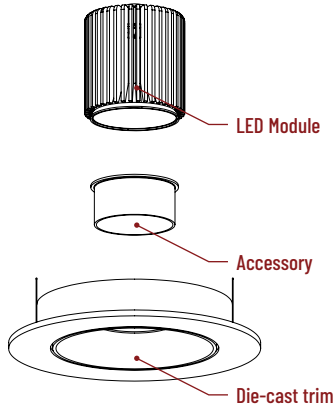

Translucent Decorative Collar

**NIO-AS14(color)**      5/8" length  
**NIO-AS19(color)**      3/4" length  
**NIO-AS26(color)**      1" length  
**Color:**  
**AM** (amber), **BLU** (blue), **FR** (frosted), **R** (red)

Translucent collars color the aperture with the specified color while producing white general light. Collars are available in different lengths. Use to add interest, create a theme, match a theme or define a space.



Opaque Collar Snoot

**NIO-AS14(color)**      5/8" length  
**NIO-AS19(color)**      3/4" length  
**NIO-AS26(color)**      1" length  
**Color:**  
**BLK** (black), **MPW** (matte powder white), **WH** (white)

Opaque snoot greatly reduces aperture brightness while preserving light output. (Note: Black snoot will reduce light)

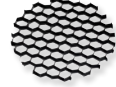

Hex Cell Louver

**NIO-HC**      Black  
 Hex cell louver subtly reduces aperture brightness by reducing light output by about 20%.

### FLUSH MOUNT

4" Iolite trims can be installed flush with the drywall for a flush mount appearance. A flush mount mud ring is installed after the drywall and a professional drywall finisher floats the ceiling to blend in the mud ring.



Flush Mount Mud Ring

**NIO-FMMR-4S**      Square Mud Ring

Mounts trim flush to ceiling with flange visible. Mud ring attaches to drywall. **Only for use with NH10ICD-48 or NH10ICDCP-48 new construction housings and NIO-4S trims.**  
 Dimensions: 7-7/8" diameter 1/2" thick

# PHOTOMETRICS

## 4" Iolite Square Reflector with Round Aperture with 10° Optic

Type \_\_\_\_\_

Project \_\_\_\_\_

Catalog No. \_\_\_\_\_

Notes \_\_\_\_\_

### Test Information

Test Number: NTR1888R2  
 Part Number: NIO-4SNDC400QWW  
 Beam Spread: 12° Spot  
 Lumens: 884lm  
 Wattage: 12.42W  
 Efficacy: 71lpw  
 CCT / CRI: 4000K / 90 CRI  
 Spacing Criteria (0°-180°): 0.22  
 Spacing Criteria (90°-270°): 0.22

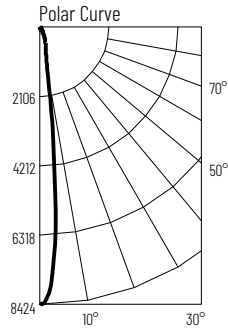

### Illuminance at a Distance

Distance from Luminaire	FC at Nadir	Beam Diameter
16'	32.8fc	3'-6"
18'	25.9fc	4'
20'	21fc	4'-5"
22'	17.3fc	4'-10"
24'	14.6fc	5'-4"

### Zonal Lumen Summary

Zone	Lumens	% Luminaire
0-30	741	83.8
0-40	833	94.1
0-60	874	98.8
0-90	884	100
90-180	0	0
0-180	884	100

### Candela Table

Vertical Angles	Candela
0	8392
5	5543
15	735
25	336
35	140
45	36

### Lumen Output Multipliers

Color Temperature: 2700K (0.9), 3000K (0.96), 3500K (0.96), 4000K (1.00)