

INSTALLATION & OPERATION INSTRUCTIONS

IMPORTANT SAFEGUARDS

1. **READ AND FOLLOW ALL SAFETY INSTRUCTIONS.**
2. Review the diagrams thoroughly before beginning. If you feel you do not have electrical wiring experience, refer to a do-it-yourself wiring handbook or have your fixture installed by a qualified licensed electrician.
3. All electrical connections must be in accordance with local codes, ordinances, and the National Electric Code. If you are unfamiliar with methods of installing electrical wiring, secure the services of a qualified licensed electrician.
4. Before starting the installation, disconnect the power by turning off the circuit breaker or by removing the appropriate fuse at the fuse box. Turning the power off using the light switch is not sufficient to prevent electrical shock.
5. Do not use outdoors.
6. Do not let power supply cords touch hot surfaces.
7. Do not mount near gas or electric heaters.
8. Use caution when servicing batteries. Battery acid can cause burns to skin and eyes. If acid is spilled on skin or in eyes, flush acid with fresh water and contact a physician immediately.
9. Equipment should be mounted in location and at heights where it will not readily be subject to tampering by unauthorized personnel.
10. The use of accessory equipment not recommended by the manufacturer may cause an unsafe condition.
11. Do not use this equipment for other than intended use.
12. All servicing should be performed by qualified personnel only.
13. Allow battery to charge for 24 hours before first use.

SAVE THESE INSTRUCTIONS

SIDE MOUNTING - DIA.5

- 1) Housing
- 2) EXIT panel
- 3) Back plate
- 4) Red or Green diffuser
- 5) Housing screws
- 6) Canopy
- 7) Canopy screws
- 8) Crossbar
- 9) Wire nuts
- 10) Junction box (Building utility)
- 12) Crossbar screws (not provided)

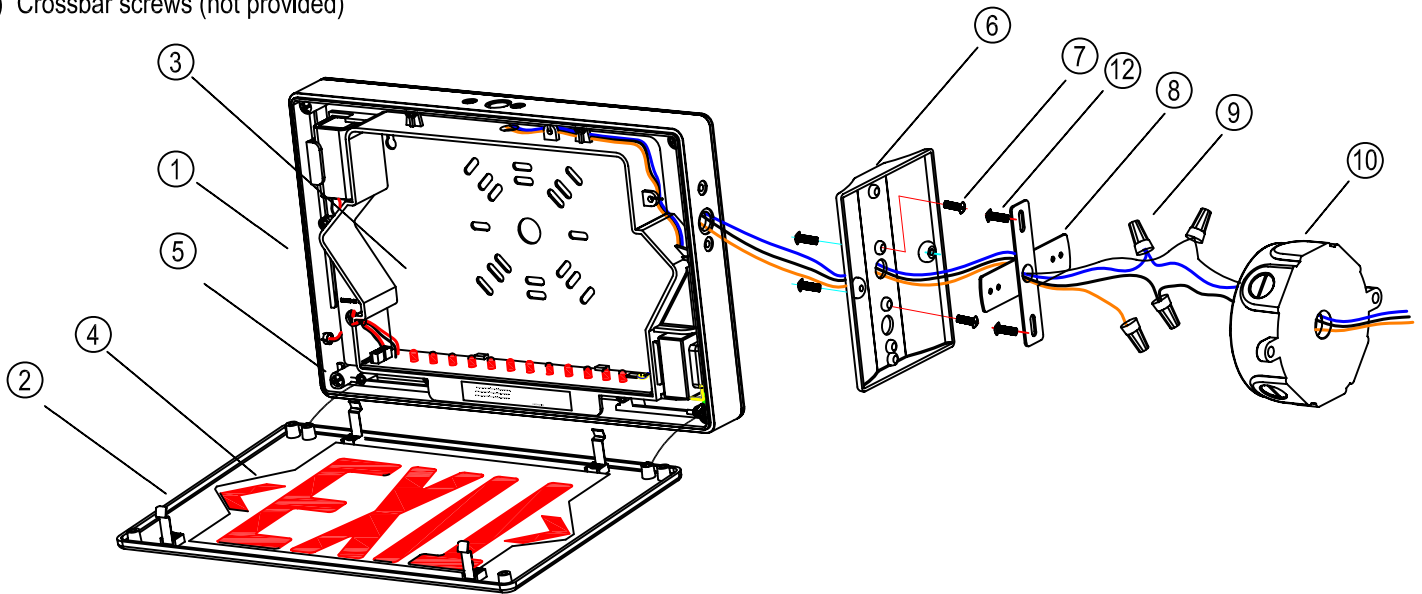

BACK MOUNTING - DIA.6

- 1) Housing
- 2) EXIT panel
- 3) Back plate
- 4) Red or Green diffuser
- 5) Housing screws
- 9) Wire nuts
- 10) Junction box (Building utility)
- 12) Crossbar screws (not provided)

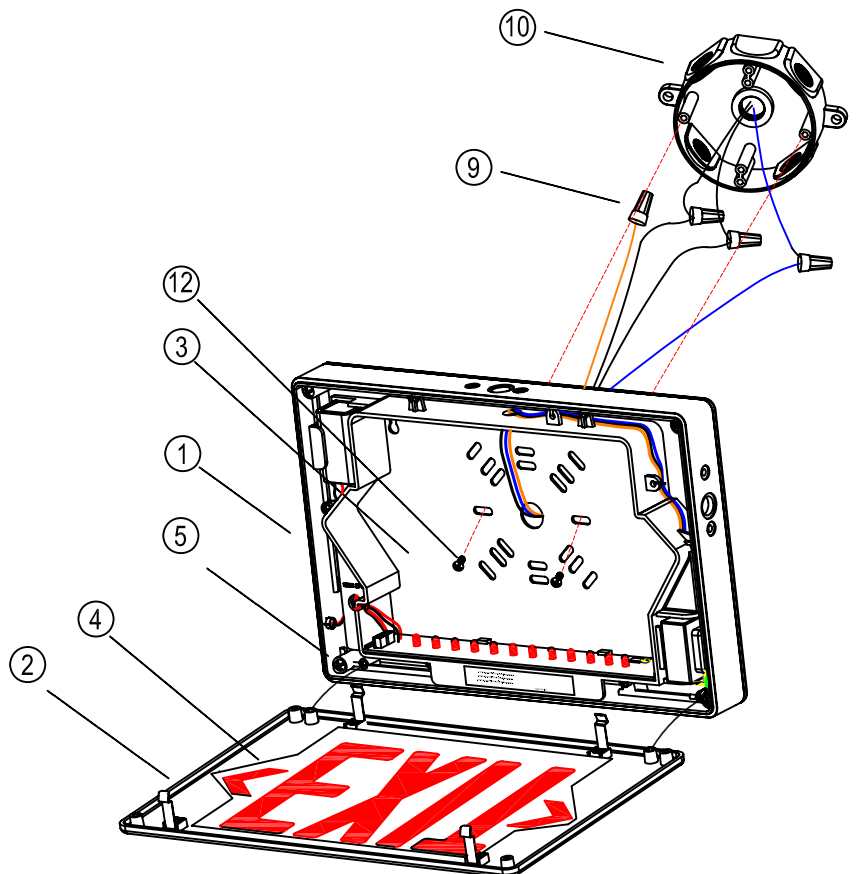

REMOVE KNOCKOUTS - DIA.7

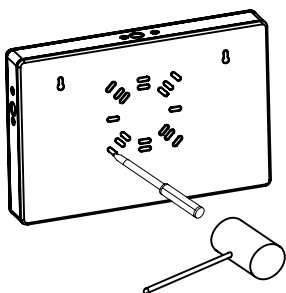

OPENING EXIT PANEL - DIA. 1

Remove EXIT panel from the housing by pulling carefully at the top of the EXIT panel

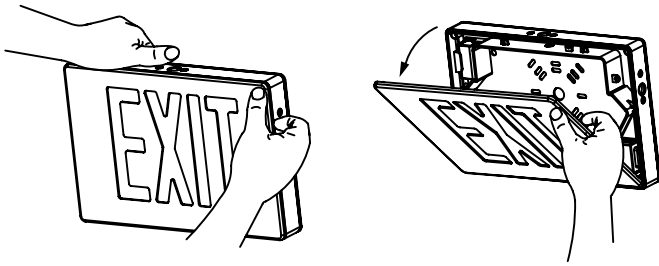

ASSEMBLING EXIT PANEL TO HOUSING - DIA. 2

Snap EXIT panel to the housing bottom first and then top

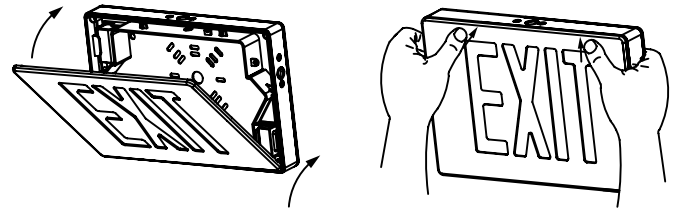

USING HOLDING WIRE - DIA. 3

Holding wire supports sign during wiring

PARTS DESCRIPTION

- 6) Canopy
- 8) Crossbar
- 10) Junction box (Building utility)
- 11) Holding wire
- 12) Crossbar screws (not provided)

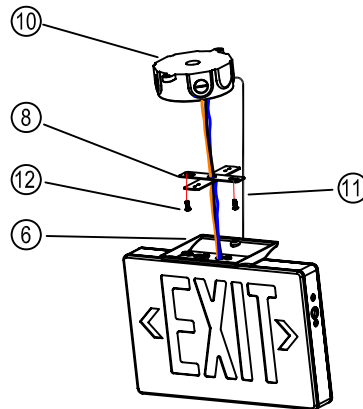

WIRING

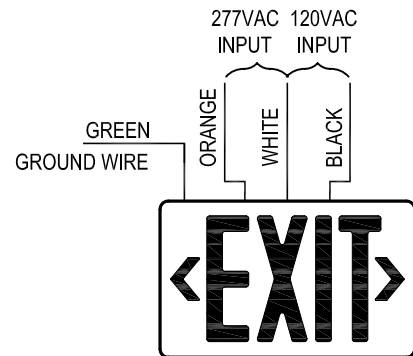

CEILING MOUNTING - DIA.4

- 1) Housing
- 2) EXIT panel
- 3) Back plate
- 4) Red or Green diffuser
- 5) Housing screws
- 6) Canopy
- 7) Canopy screws
- 8) Crossbar
- 9) Wire nuts
- 10) Junction box (Building utility)
- 12) Crossbar screws (not provided)

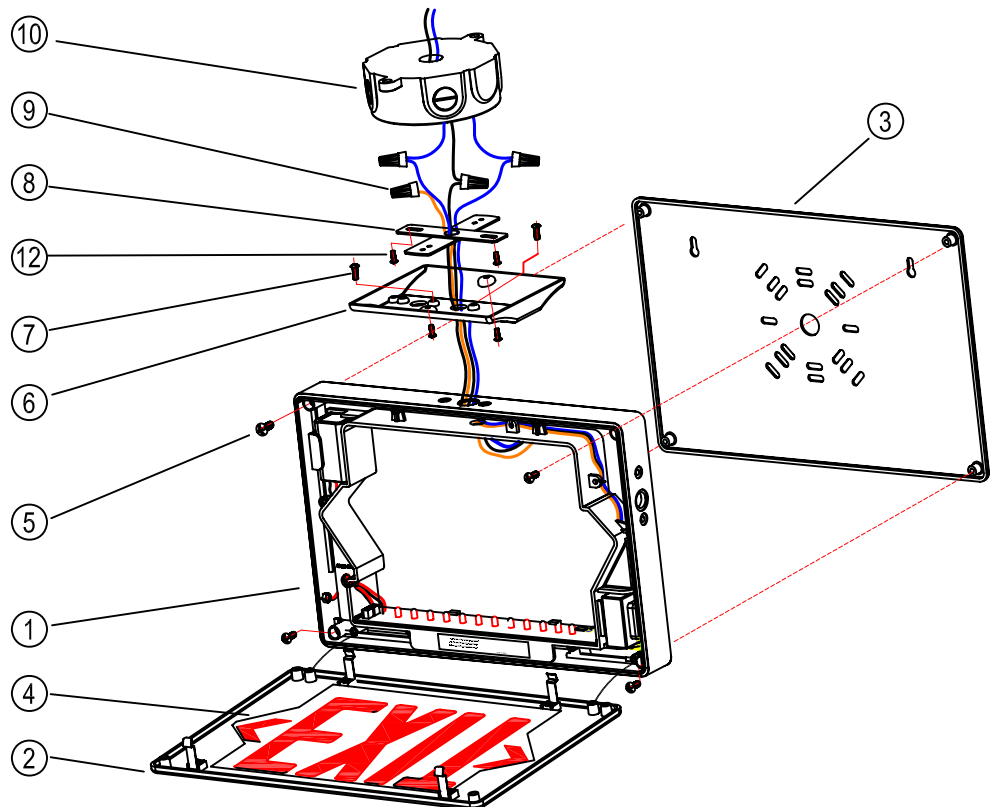

ELECTRICAL CONNECTIONS

1. First turn off the AC power before making any electrical connections.
2. Connect battery to charge circuit board before connecting AC power.

Ceiling (See diagram 4) or Side mounting (See diagram 5)

Single or Double Face

1. Open EXIT panel from the housing (see diagram 1) and remove the hole plugs from the top (or side) of the housing, if necessary.
2. Remove the proper directional chevron(s) from the EXIT panel(s) carefully, if necessary.
(**CAUTION:** Carefully remove the knock outs only otherwise it may cause damage on the surface).
3. FOR DOUBLE FACE;
 - (1) Remove the back plate from the housing by removing housing screws (4pcs) at the corner of the Exit housing.
 - (2) Then assemble the additional EXIT panel using the housing screws (4pcs) with the housing.
(**NOTE:** The additional EXIT panel does not have any clips)
4. Secure canopy to the housing using hole numbers “2” and “3” on the canopy with provided canopy screws ((2) # 10-24 screws).
5. Feed AC supply leads through top (or side) hole on the housing and the crossbar, then make the proper supply lead connections. If using 120VAC, connect the black and white leads to the building utility. If using 277VAC, connect the orange and white leads to the building utility. Cap off unused wire. If the unit is self-powered, be sure to snap battery connector together. During installation, use the enclosed “ holding wire” for assistance. (See diagram 3)
6. Push excess wire into junction box and align holes in canopy with those in crossbar. Using screws supplied, tighten canopy to crossbar so that canopy is securely fastened and tight against ceiling (or wall).
7. Snap EXIT panel into the housing, bottom first and then top. (See diagram 2)

Back Mounting (See diagram 6)

1. Open EXIT panel (see diagram 1) and remove the proper directional chevron(s) from the EXIT panel carefully, if necessary.
(**CAUTION:** Carefully remove the knock outs only otherwise it may cause damage on the surface)
2. Remove the knock out hole on the center of back plate. Then remove the oblong knock outs on the back plate that correspond to junction box holes to be used.
3. Feed AC supply leads through center hole on the back plate, then make the proper supply lead connections. If using 120VAC, connect the black and white leads to the building utility. If using 277VAC, connect the orange and white leads to the building utility. Cap off unused wire. If the unit is self-powered, be sure to snap battery connector together.
4. Feed excess wire into junction box and secure back plate to junction box.
5. Snap EXIT panel into the housing, bottom first and then top. (See diagram 2)