

Installation Instructions

NUD-88

LEDUR LED Undercabinet

READ PRIOR TO ATTEMPTING INSTALLATION
ALWAYS TURN OFF MAIN POWER BEFORE INSTALLATION
INSTALLATION SHOULD BE CARRIED OUT BY YOUR LOCAL ELECTRICIAN

⚠ FIRE/ELECTRICAL HAZARD: INSTALL ACCORDING TO NATIONAL ELECTRIC CODE AND ANY APPLICABLE MUNICIPAL CODE REQUIREMENTS. - This equipment is intended to be installed only by qualified personnel. The installation must be made in accordance with the current edition to the National Electric Code and all applicable state and local building codes. The final installation must be approved by the appropriate qualified electrical/building inspector(s). Improper installation may result in a fire or electrical hazard. Be sure the electrical power to the circuit has been disconnected before installing this electrical system.

⚠ RISQUE D'INCENDIE / D'ÉLECTRICITÉ: INSTALLER SELON LE CODE ÉLECTRIQUE NATIONAL ET TOUTES LES EXIGENCES RELATIVES AU CODE MUNICIPAL APPLICABLE. - Cet équipement est destiné à être installé uniquement par du personnel qualifié. L'installation doit être faite conformément à l'édition actuelle du Code national de l'électricité et de tous les codes de construction locaux et nationaux applicables. L'installation finale doit être approuvée par un ou plusieurs inspecteurs qualifiés en électricité / bâtiment. Une installation incorrecte peut entraîner un incendie ou un risque électrique. Assurez-vous que l'alimentation électrique du circuit a été déconnectée avant d'installer ce système électrique.

MOUNTING THE FIXTURE

1. Remove captive mounting screw covers.
2. Place fixture in desired position and drive Mounting Screws Securely. In some installations it may be desired to drill a pilot hole for the screws.
3. Replace the Captive Mounting Screw Cover.

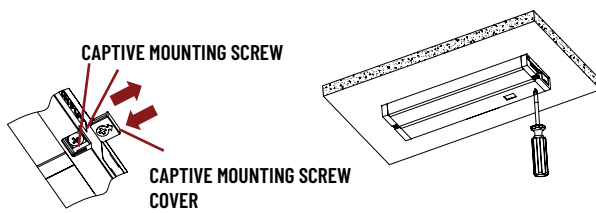

NOTE: Should captive mounting not line up with application, there are key-hole mounting holes under front cover.

POWER CORD CONNECTION

Remove the Electrical Port Cover and insert the power cord into INPUT electrical port.

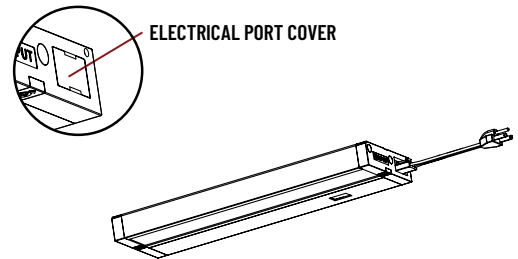

NOTE: Port covers are labeled "INPUT" and "OUTPUT". Use "INPUT" for power and "OUTPUT" when linking to another NUD unit.

JOINING MULTIPLE FIXTURES

USING JUMPER CORD:

1. Remove Electrical Port Covers.
2. Connect INPUT of Jumper cord to INPUT of electrical port.
3. Connect OUTPUT of Jumper cord to OUTPUT of electrical port.

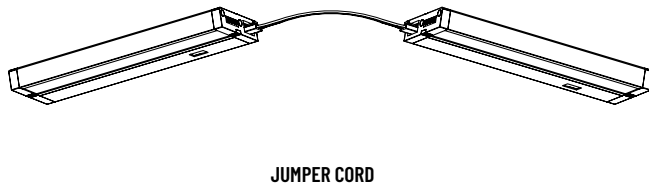

USING END-TO-END CONNECTOR:

1. Remove Electrical Port Covers.
2. Connect INPUT of End-to-End connector to INPUT of electrical port.
3. Connect OUTPUT of End-to-End connector to OUTPUT of electrical port.

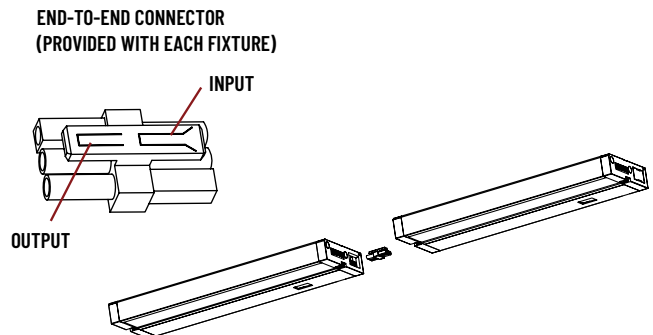

Installation Instructions

NUD-88

LEDUR LED Undercabinet

READ PRIOR TO ATTEMPTING INSTALLATION
ALWAYS TURN OFF MAIN POWER BEFORE INSTALLATION
INSTALLATION SHOULD BE CARRIED OUT BY YOUR LOCAL ELECTRICIAN

WIRING CONNECTIONS THROUGH A SIDE ACCESS DOOR

1. Loosen screw that secures the side access door and remove the door from key hole by just sliding the door. (Figure 1)
2. Assemble the 3/8" die-cast connector into side access door (Figure 2) and push the supply cable through the die-cast connector. (Figure 3)
3. Inside fixture, are three wires with push-in connectors. Carefully pull these out of the fixture.
NOTE: Do not pull with excessive force.
4. Insert each of the three wires from the supply cable into each of the three push-in connectors with respective color wires.
5. Neatly push wires and push-in connectors into opening in back of the fixture.
6. Close the side access door and tighten screw.

Figure 1

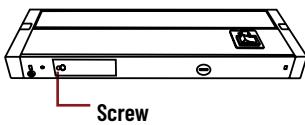

Figure 2

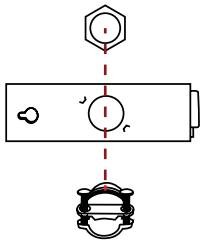
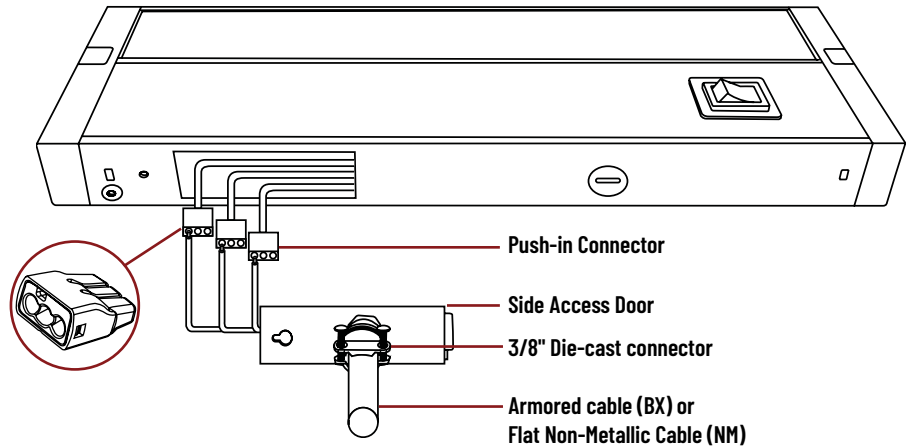

Figure 3



ALTERNATE POWER METHODS

There are knockouts on the top and rear should the side access not meet the requirements. If these knockouts are to be used, it will require you to open the front cover to complete wiring. Gently pry open cover with tool provided or with a small regular screw driver. Make wiring connections. To close door, swing up next to unit and snap in place. NUD can also be powered using "Input" ports with a cord and plug or hard wire accessories (not included).

