

**HARMONIX** – model: PD-87914  
LED Interior Pendants & Chandeliers

MODERN FORMS



Fixture Type:

Catalog Number:

Project: \_\_\_\_\_

Location: \_\_\_\_\_

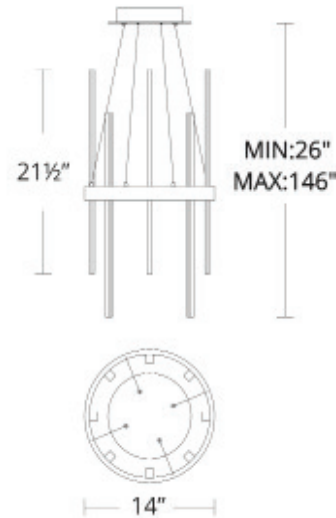

**PRODUCT DESCRIPTION**

Like a dynamic instrument of musical chimes. Harmonix plays to the rhythm of light. Beautiful playful light. A two tone finish features black with aged brass.

**FEATURES**

- Frosted diffusers spread light evenly
- Universal Driver (120V-277V) concealed within the canopy
- Thin power aircraft cables provide an ultra clean look for adjustable suspension height
- Quick spin-on canopy design with minimal hardware for easy installation
- Dimming: ELV, 0-10V
- Rated Life: 50,000 hours
- Color Temp: 3000K
- CRI: 90

**ORDER NUMBER**

	Size	Wattage	Voltage	LED Lumens	Delivered Lumens	Finish
<b>PD-87914</b>	14"	47W	120V-277V	2742	2660	<b>BK/AB</b> Black/Aged Brass

Example: **PD-87914-BK**

**SPECIFICATIONS**

**Construction:** Aluminum body with acrylic diffuser

**Light Source:** High output LED

**Finish:** Black/Aged Brass (BK/AB)

**Standards:** ETL & cETL Damp Location listed, Title 24 Compliant

modernforms.com  
Phone (800) 526.2588  
Fax (800) 526.2585

Headquarters/Eastern Distribution Center  
44 Harbor Park Drive  
Port Washington, NY 11050

Central Distribution Center  
1600 Distribution Ct  
Lithia Springs, GA 30122

Western Distribution Center  
1750 Archibald Avenue  
Ontario, CA 91760