

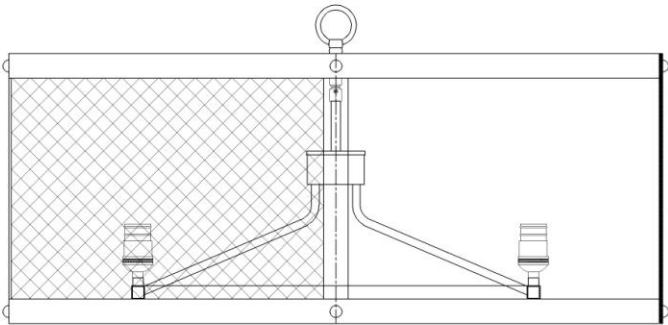

PRODUCT NAME: Palladium 6 Light Chandelier  
ITEM NUMBER: 20114BKNAB

Please consult your electrician for hanging fixture and wiring.



Bulb (not included): 6\*60w E26 Bulbs

PRODUCTS ARE NOT INENDED  
FOR COMMERCIAL USE.

MADE IN CHINA  
Page 1 of (2)

**IMPORTANT:** Turn off the power at the main fuse or circuit breaker box before starting installation

Locate all hardware & components before discarding packaging

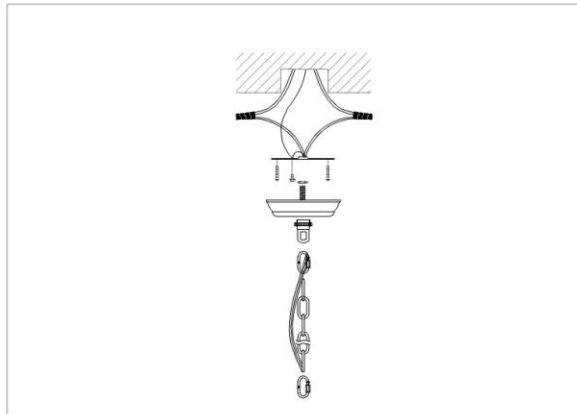
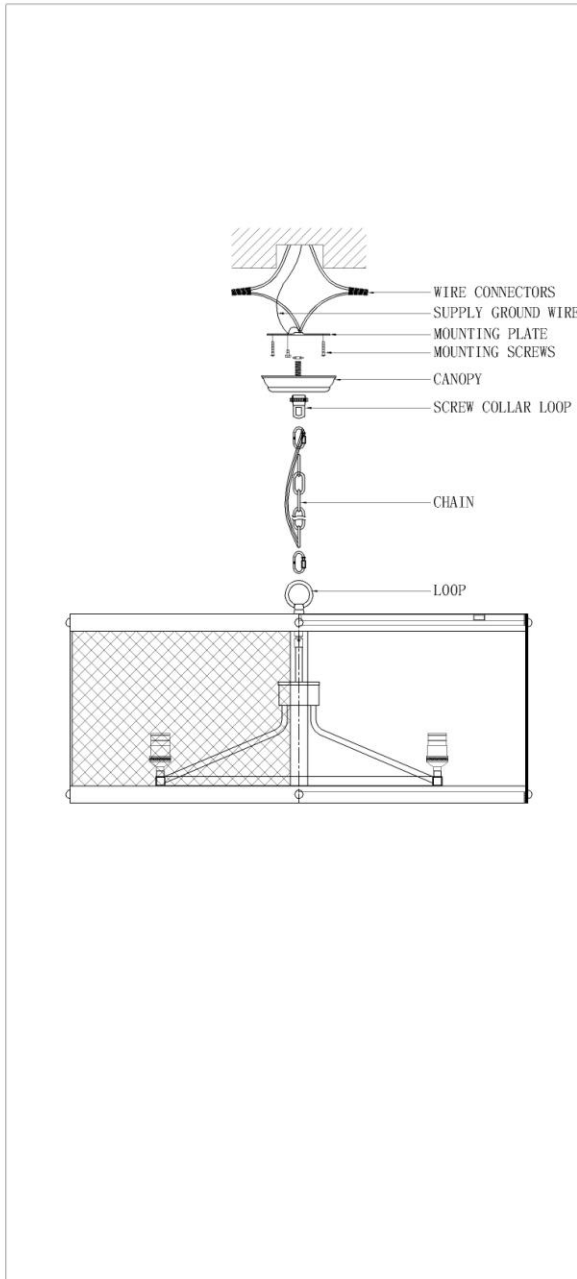

1. Remove mounting bracket from fixture and install to electrical box.
2. Attach appropriate amount of chain to loop to achieve desired mounting height. Thread wire through every 3rd loop of chain.
3. Remove screw ring from collar loop and slide down chain. Place canopy onto chain. Install nipple and cross bar into top of chain loop.
4. Wire fixture to wires in outlet box. Positive to black supply wire, neutral to white supply wire. Silver wire is for Ground.
5. Pull canopy through screw ring up chain to ceiling and tighten securely.

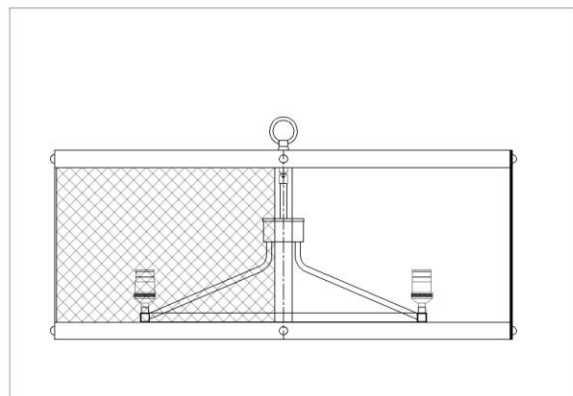

6. Install max 60W vintage Edison bulbs (recommended).