

LED Flush Mount

FM43522-5CCT

INSTALLATION SHEET

START FROM HERE

- Make sure **POWER** is **COMPLETELY OFF** at the fuse box
- Have your fixture installed by a qualified licensed electrician
- Prepare everything in a clear area
- Wear gloves at all times during this installation
- Read instructions carefully before you start assembly
- Keep this installation sheet for future reference

Please Note:

- This Kuzco LED fixture comes with pre-wired LED module(s)
- Unless instructed, Do Not touch any part of the LED module(s) as any unnecessary contact with the module could cause permanent damage
- For dimming, an ELV (Electronic Low Voltage) type of dimmer is required
- 120V input

Technical Support: 1-855-855-8926

1. Remove fixture from its original package
2. Attach crossbar (1c) to electrical junction box (1a) using screws provided (1e) in hardware package
3. Make proper electrical connections (black to hot "L", white to neutral "N", ground to "GND") with wire nuts (1b) provided in hardware package
4. Install Pan-Head Crossbar Mounting Screws (1d) halfway into threaded holes on crossbar (1c). Align keyholes on backplate (2a) and module to Pan-Head Crossbar Mounting Screws (1d) heads, insert and turn, and then secure with screw driver.
5. Secure backplate (2a) to ceiling with additional screws (1g) and anchors (1f) if necessary
6. Choose color temperature by using slider (5a)
7. Twist shade (3a) onto backplate (2a) to secure

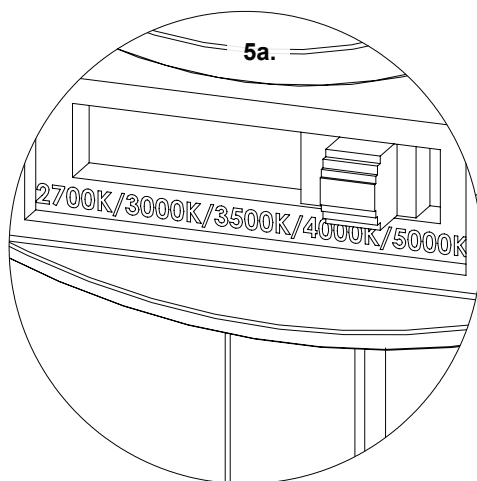
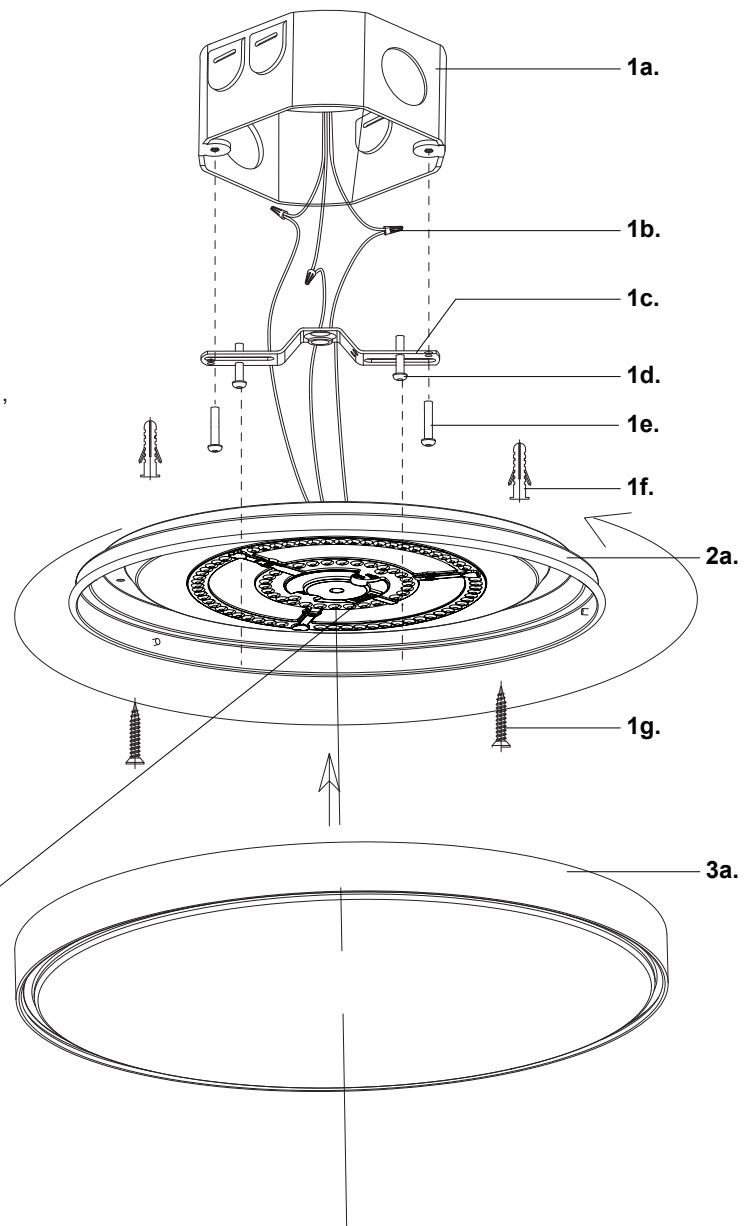

KUZCO

19054 28th Avenue Surrey, BC Canada V3Z 6M3
T: 604 538 7162 TF: 1-855 85 KUZCO F: 604 538 7196
W: kuzcolighting.com
20230926