

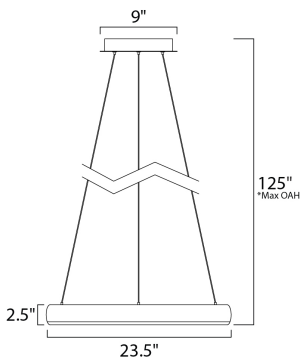

PRODUCT DESCRIPTION

Doughnut shaped rings finished in a beautiful Satin Nickel create a soft contemporary design. LEDs are mounted at an angle to evenly illuminate the entire diffuser a soft diffused light.



*max overall height

MEASUREMENTS

- DIMENSION : 23.5" L x 23.5" W x 2.5" H
- MAX OAH : 125" OAH
- CANOPY : 9" W x 1.25" H x 9" L
- HANGING WEIGHT : 8 lb

LAMPING

- INPUT VOLTAGE : 120V
- LUMENS : 1,540 Rated
- BULB : 1 x 28W LED PCB Integrated , 28W Total
- BULB INCLUDED : (Integrated)
- DIMMABLE : Triac CL
- CRI : 80+ CRI
- COLOR_TEMP : 3000K

FINISHES OPTION



MATERIAL

Steel, Acrylic

RATINGS

cETLus
Dry Location



ADDITIONAL

ADJUSTABLE
RATED LIFE 35000 Hours
OPERATING TEMPERATURE:
-20°C (-4°F), 40°C (104°F)

Always consult a qualified electrician before installing any lighting product.



WESTERN DISTRIBUTION CENTER (HEADQUARTER)
253 NORTH VINELAND AVE | CITY OF INDUSTRY, CA 91746
EASTERN DISTRIBUTION CENTER
4200 SHIRLEY DR. | ATLANTA, GA 30336
P. 626.956.4200 | F. 626.956.4225 | et2online.com