

# LIVING DISTRICT

Collection:Felicity















Installation manual for:

LD4013W6 W5.7"H12"E9.9"L1

## Installation instructions:

- 1.Using the screw (P3) secure the mounting bracket (P1) to the junction box.
  2. Black wire from ceiling(junction box) attaches to "L"wire from the fixture.
  - 3.White wire from ceiling(junction box) attaches to "N"wire from the fixture.
  4. "E" wire from the fixture is attached to the mounting bracket and an additional "E" wire from the mounting bracket must be secured to the junction box.
  - 5.M4 screw (P2)pass through the holes in canopy plate and tighten by nut (P6).
  - 6.Loosen the screw (P12) then insert the lampshade (P14) to metal cover (P11) tighten finally.
  - 7.Install the bulb(not included) in lamp holder (P10).
- The end!

## PARTS LIST

| part | picture   | Description                   | Qty | Check list |
|------|---|-------------------------------|-----|------------|
| P1   |  | Ø4.0" Mounting bracket        | 1   |            |
| P2   |  | M4 Screw                      | 2   |            |
| P3   |  | 5/32-32 Screw                 | 2   |            |
| P4   |  | Power Cord 9" 20# Black+white | 1   |            |
| P5   |  | Ø4.7" Back plate              | 1   |            |
| P6   |  | Nut                           | 2   |            |
| P7   |  | Metal arm                     | 1   |            |
| P8   |  | Threaded pipe                 | 1   |            |
| P9   |  | Lamp cup                      | 1   |            |
| P10  |  | E26 Lamp holder               | 1   |            |
| P11  |  | Metal cover                   | 1   |            |
| P12  |  | Screw                         | 3   |            |
| P13  |  | E26 Lamp holder ring          | 1   |            |
| P14  |  | 5.7"Lampshade                 | 1   |            |
|      |   |                               |     |            |

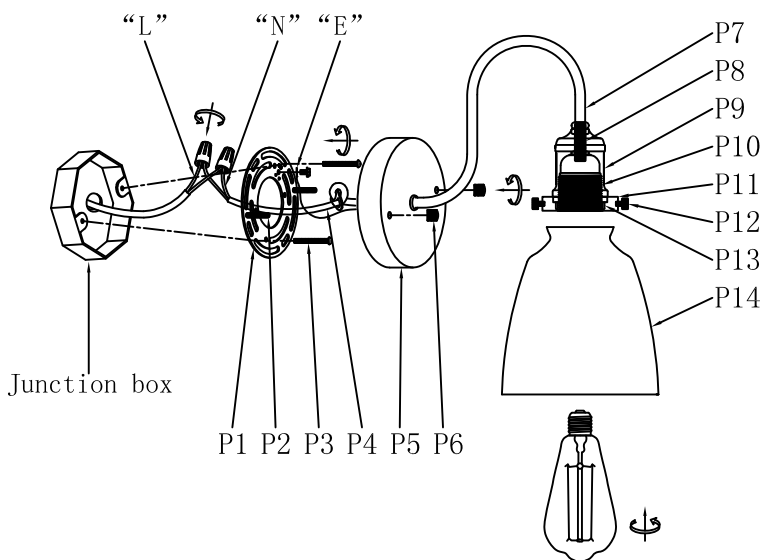

"L" = Hot wire  
 "N" = Neutral wire  
 "E" = Ground wire