

ER SERIES - TRIPLETS™ - 3 PHASE - LOW ACTIVATION

IDEAL APPLICATIONS: Showers, Mop Sink

PRODUCT FEATURES

- Uses a digital microprocessor for temperature control
Ultra quick response times for temperature variations - 120 times per second. Microprocessor use is the most energy efficient means of heating water
- Unlimited hot water
- Ideal for sensor/hands-free faucets, no mixing valve needed
- Saves water and energy - 99% energy efficient
- Works on low flow - 0.35 GPM (1.30 LPM) Activation
- Rugged steel housing (Standard)
- Space saving compact size:
15-1/4" x 17-1/2" x 6-1/4"
(387 x 445 x 159mm)
- Meets applicable building codes including UL, UPC.
- Environmentally friendly
- Made in the U.S.A.
- User adjustable temperature 70°F-125°F (21°C-52°C) (Standard)
- Optional factory preset temperature available, Select single temperature between 90°F-160°F (32°C-71°C)
- Multiple applications handled with one heater



Large Capacity - 3 Phase - Low Activation

Chronomite Instant-Temp® - High Capacity - 3 Phase - Low Activation - L3 models are manufactured to provide reliable hot water with flow rate from 0.35 GPM to 4.5 GPM (1.3 LPM to 17.0 LPM). There is no pressure and temperature relief valve needed (unless required by code), saving time and money on installation.

Housing is fabricated from rugged Jet-Kote gray steel.

Element assembly is fabricated from Celcon plastic.

Heating Coils are nichrome.

GUIDE SPECIFICATION

Tankless Water Heater shall be a Chronomite Laboratories Model

ER - _____ L / _____ 3P
VOLTS

with _____ AMPS/PHASE and _____ Volts

Unit shall be provided with Celcon/ Delrin waterways, and Nichrome heating coils. Temperature controlled by microprocessor.

OPTIONS

- Satin Finish Stainless Steel Housing (SS)
- De-ionized (DI)
- Factory Preset (F)
- Auxiliary Contact (A)
- Digital Readout (DR)
- Y - Strainer (Y)
- A-810VR-2.0 2.0 GPM Hose Bib Adapter
- A-810VR-2.5 2.5 GPM Hose Bib Adapter
- Disconnect Switch, Rotary 80A - Lockable Nema 4X (2095-4)
- NEMA 4 Cabinet (N4)
- NEMA 4X Cabinet (N4X)



Member of U.S. Green Building Council



Water Conserving Product



Made in the USA

For the model being selected, please place the corresponding amps, volts and watts values in the Guide Specifications above.

MODEL	AMPS/PHASE	3 Ø VOLTAGE	WATTS	ACTIVATION GPM	TEMP RISE @ 3.00 GPM	TEMP RISE @ 3.75 GPM	TEMP RISE @ 4.50 GPM
ER-90L/208_3P	52	208	18700	0.35	43	34	28
ER-42L/480_3P	24	480	20000	0.35	46	36	30
ER-90L/240_3P	52	240	21600	0.35	49	39	33
ER-50L/480_3P	29	480	24000	0.35	55	44	36
ER-120L/208_3P	69	208	24960	0.35	57	45	38
ER-120L/240_3P	69	240	28800	0.35	66	52	44
ER-60L/480_3P	35	480	28800	0.35	66	52	44
ER-67L/480_3P	38	480	32000	0.35	73	58	49
ER-90L/480_3P	52	480	43200	0.35	98	79	66

Complies with Standards for:



CALGreen

CHRONOMITE LABORATORIES, INC.

17451 Hurley St. :: City of Industry, CA 91744
Phone 800-447-4962 :: 626-937-4270
Fax 626-937-4279 :: www.chronomite.com

MEMBER OF



ER SERIES - TRIPLETS™ - 3 PHASE - LOW ACTIVATION

LOW ACTIVATION-ER-3P SERIES / TRIPLETS METRIC CHART

MODEL	AMPS/PHASE	3 Ø VOLTAGE	WATTS	ACTIVATION LPM	TEMP RISE @ 12.00 LPM	TEMP RISE @ 14.50 LPM	TEMP RISE @ 17.00 LPM
ER-60L/380_3P	35	380	22800	1.3	27	23	19
ER-60L/415_3P	35	415	24900	1.3	30	25	21
ER-43L/600_3P	25	600	25600	1.3	31	25	22
ER-90L/380_3P	52	380	34200	1.3	41	34	29
ER-90L/415_3P	52	415	37350	1.3	45	37	32
ER-64L/600_3P	37	600	38300	1.3	46	38	32
ER-85L/600_3P	49	600	51100	1.3	61	51	43

TECHNICAL DIMENSIONS

LARGE CAPACITY - 3 PHASE- LOW ACTIVATION

Dimensions:	387 x 445 x 159mm
Weight:	11.8 Kg
Materials:	Rugged steel housing Celcon plastic element assembly with nichrome coils
Minimum Operating Flow Rate:	1.3 LPM
Minimum Operating Pressure:	172 kPa
Maximum Operating Pressure:	552 kPa
Maximum Pressure	1034 kPa
Maximum Water Temperature:	71°C
Maximum Ambient Operating Temperature:	60°C
Listing:	ETL

GENERAL NOTES:

- The microprocessor adjusts the heater's power for variations in flow rates, inlet water temperature and pressure to assure the selected water temperature.
- 240V models when operated at 220V will have approximately a 15% wattage decrease.

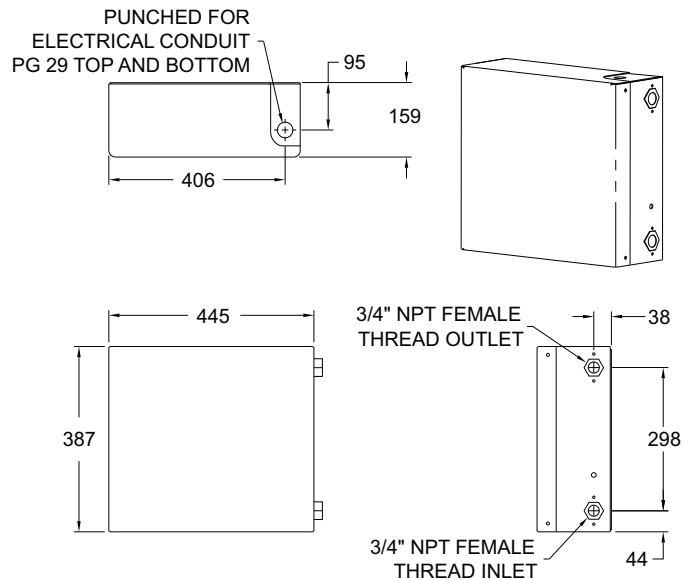

Chronomite Laboratories assumes no responsibility for use of void or suspended data. © Copyright Chronomite Laboratories, Inc. Acorn Family of Companies, City of Industry, CA Please visit www.chronomite.com for most current specifications.

SELECTION SUMMARY & APPROVAL FOR MANUFACTURING	Company _____	
	Model Number & Options _____	Quantity _____
	Contact _____	Title _____
	Signature (Approval for Manufacturing) _____	Date _____
	CHRONOMITE LABORATORIES, INC. PH. 800-447-4962 626-937-4270 FAX 626-937-4279 www.chronomite.com	

ER SERIES - TRIPLETS™ - 3 PHASE - LOW ACTIVATION

TECHNICAL DIMENSIONS

LARGE CAPACITY - 3 PHASE- LOW ACTIVATION

Dimensions:	15-1/4" x 17-1/2" x 6-1/4"
Weight:	26 LBS
Materials:	Rugged steel housing Celcon plastic element assembly with nichrome coils
Minimum Operating Flow Rate:	0.35 GPM
Minimum Operating Pressure:	25 PSI
Maximum Operating Pressure:	80 PSI
Maximum Pressure	150 PSI
Maximum Water Temperature:	160°F
Maximum Ambient Operating Temperature:	140°F
Listing:	UL, UPC

GENERAL NOTES:

- The microprocessor adjusts the heater's power for variations in flow rates, inlet water temperature and pressure to assure the selected water temperature.
- 240V models when operated at 220V will have approximately a 15% wattage decrease.

PUNCHED FOR 1" CONDUIT,
TOP AND BOTTOM

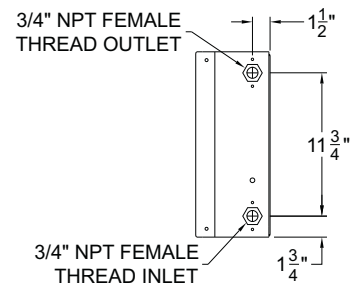
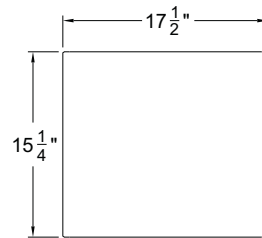
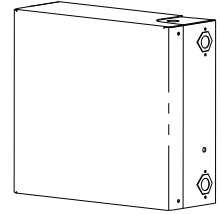
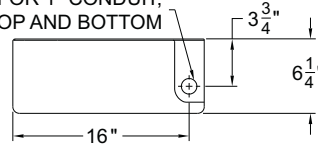

INSTALLATION DIAGRAM

Shown Installed with (2) Three
Station Meridian Lavys

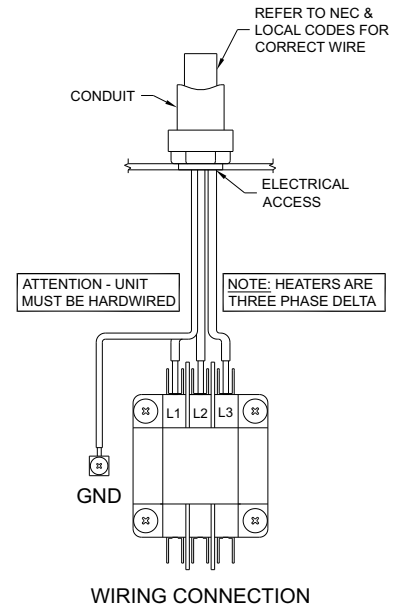
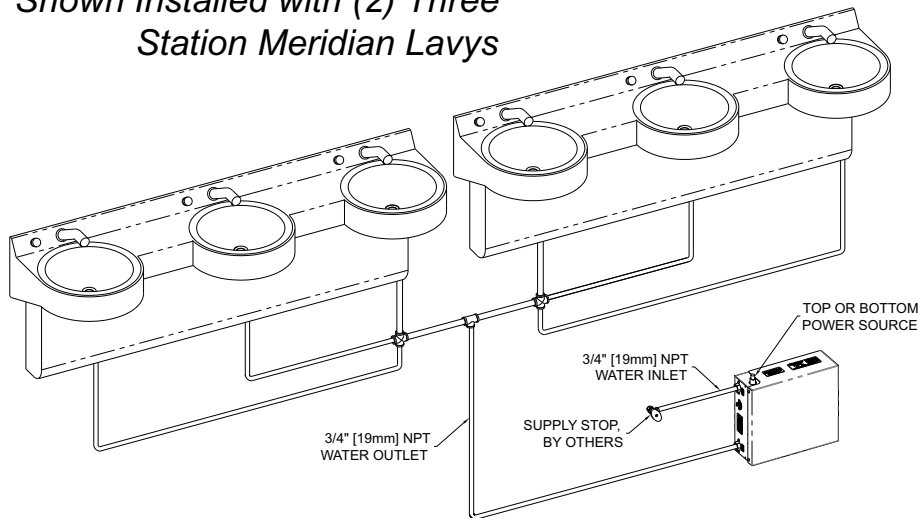

Chronomite Laboratories assumes no responsibility for use of void or suspended data. © Copyright Chronomite Laboratories, Inc. Acorn Family of Companies, City of Industry, CA Please visit www.chronomite.com for most current specifications.

SELECTION SUMMARY
& APPROVAL FOR
MANUFACTURING

Company _____

Model Number & Options _____ Quantity _____

Contact _____ Title _____

Signature
(Approval for
Manufacturing) _____

Date _____

CHRONOMITE
LABORATORIES, INC.

PH. 800-447-4962

626-937-4270

FAX 626-937-4279

www.chronomite.com