

MECHANICAL FAUCETS

982-937CHAGVCP

Needle Valves



Product Type

Deck Mounted Two Needle Valves Turret with Two Needle Valves at 90°

Features & Specifications

- Two Needle Valves
- Full Flow Nozzle
- 2-1/2" Vandal Proof Cross Handles
- Needle Valve Compression Operating Cartridges
- 3/8" NPT Female Thread Inlet
- May Be Used with Most Laboratory Gases
- 937 Valve is Certified for Gas Service per ANSI Z21.15b-2006/CSA 9.1b-2006 by the Canadian Standards Association

Performance Specification

- Rated Operating Pressure: PSI
- 0-0.5 PSI**

Compatibility by Service (Maximum Pressure):

- Acetylene (125 PSI)
- Ammonia (125 PSI)
- Argon (125 PSI)
- Butane (125 PSI)
- Carbon Dioxide (125 PSI)
- Carbon Monoxide (125 PSI)
- Helium (125 PSI)
- Hydrogen (125 PSI)
- Natural Gas (125 PSI)
- Methane (125 PSI)
- Nitrogen (125 PSI)
- Propane (125 PSI)
- Air (125 PSI)
- Compressed Air (125 PSI)

Warranty

- Lifetime Limited Faucet Warranty
- 5-Year Limited Cartridge Warranty
- 1-Year Limited Finish Warranty

Codes & Standards

- **ANSI Z21.15/CSA 9.1

Job Name _____

Item Number _____

Section/Tag _____

Model Specified _____

Architect _____

Engineer _____

Contractor _____

Submitted as Shown Submitted with Variations

Date _____



2100 South Clearwater Drive
Des Plaines, IL
P: 847/803-5000
F: 847/803-5454
Technical: 800/TEC-TRUE
www.chicagofaucets.com

Architect/Engineer Specification

Chicago Faucets No. 982-937CHAGVCP, Dual Needle Valves with Turret, deck-mounted, valves mounted at 90°. Chrome plated. Serrated, full-flow laboratory nozzle. 2-1/2" metal, vandal-proof, cross handle with eight-point, tapered broach. Includes buttons indexed "AIR", "GAS", and "VAC". 3/8" NPT female thread inlet. May be used with most laboratory gases. 937 Valve is Certified for Gas Service per ANSI Z21.15b-2006/CSA 9.1b-2006 by the Canadian Standards Association.

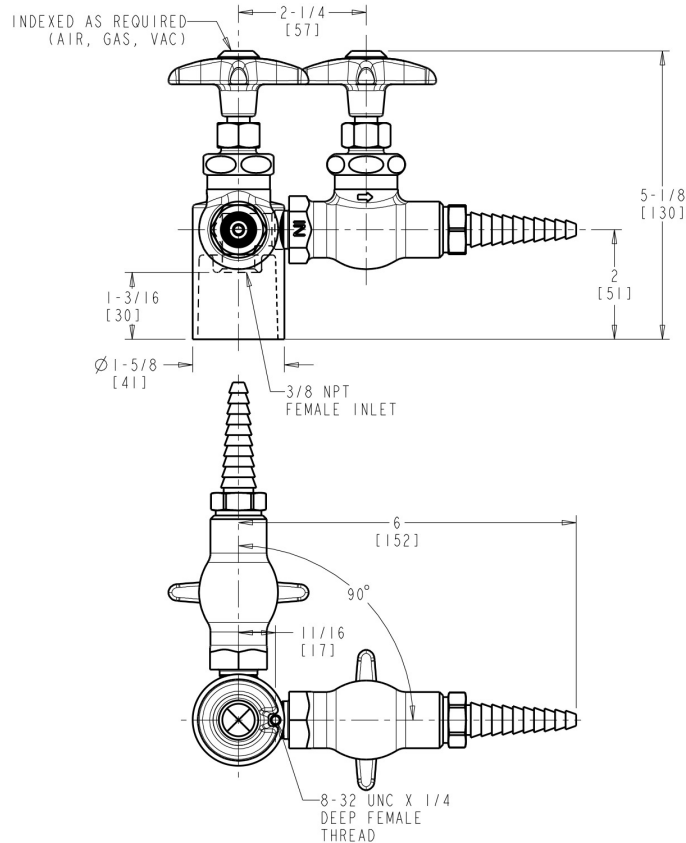

Operation and Maintenance

Installation should be in accordance with local plumbing codes. Flush all pipes thoroughly before installation. After installation, remove spout outlet or flow control and flush faucet thoroughly to clear any debris. Care should be taken when cleaning the product. Do not use abrasive cleaners, chemicals or solvents as they can result in surface damage. Use mild soap and warm water for cleaning and protecting the life of Chicago Faucet products. For specific operation and maintenance refer to the installation instructions and repair parts documents that are located at www.chicagofaucets.com.

Chicago Faucets, member of the Geberit Group, is the leading brand of commercial faucets and fittings in the United States, offering a complete range of products for schools, laboratories, hospitals, office buildings, food service, airports and sport facilities. Call 1.800.TECTRUE or 1.847.803.5000 Option 1 for installation or other technical assistance.

