

238-42 THEORY 30" PENDANT INSTALLATION INSTRUCTIONS

⚠ WARNING

DISCONNECT POWER BEFORE RE-LAMPING OR WIRING THE FIXTURE
READ ALL INSTRUCTIONS COMPLETELY BEFORE STARTING INSTALLATION.

⚠ CAUTION

- TO AVOID THE RISK OF FIRE OR SHOCK, FIXTURE MUST BE INSTALLED IN COMPLIANCE WITH ALL APPLICABLE NATIONAL AND LOCAL ELECTRICAL/BUILDING CODES.
- INSTALLATION AND MAINTENANCE OF THIS UNIT REQUIRES AN ELECTRICIAN OR CERTIFIED FACTORY TRAINED TECHNICIAN.
- If an existing fixture is being replaced, remove it and note to which of the wires in the outlet box the fixture was attached. DO NOT SEPARATE ANY OTHER WIRES THAT MAY BE IN THE BOX. DO NOT DAMAGE THE INSULATION OF OLDER WIRING. In regular circumstances the BLACK wire will be the "Hot" lead and the WHITE wire will be the "Neutral" or "Common" lead. In older buildings it is always good practice to reconfirm the polarity of the wiring.

NOTICE

- The important safeguards and instructions outlined on this sheet cannot cover all possible conditions and situations that may occur, it must be understood that common sense, caution and care factors that cannot be built into any product. Caution and care must be supplied by the person(s) installing, operating and caring of this lighting fixture.
- This fixture is designed to be mounted on a correctly installed standard round or octagon box or a through wiring box with a plaster frame. The box must be securely mounted to the structure of the building. The fabricated crossbar and hardware supplied should be used. Directly mounting the fixture to the outlet box may make it impossible to correctly align the fixture.

FIXTURE PREPARATION

1. Remove the fixture, glass and parts bag(s) from the carton.

NOTICE:

- Before discarding the carton, double check to make certain that all parts are found.

FIXTURE INSTALLATION

1. Attach SAFETY CABLE on building structure or brace. (See figure-1)

⚠ WARNING

REFER TO THE ILLUSTRATION FOR CORRECT AND SAFE INSTALLATION OF SAFETY CABLE. FAILURE TO FOLLOW THIS INSTRUCTION COULD RESULT HARM/DAMAGE TO THE FIXTURE, PROPERTY AND/OR PERSON(S)!

2. Determine the overall desired length of the fixture. Assemble the adjustable stems one at a time onto the fixture leads. Tape the end of the leads to a stiff wire (coat hanger) to aid in pulling them through the stems. Place the canopy onto the stem. Assemble the top stem section, decorative breaker, fixture stem and swivel. Place the swivel blocker over the nipple of the canopy and thread the hex nuts onto them.
3. Attach the modified heavy duty strap to the outlet box. (The green screw should face the floor). Thread the studs into the heavy duty strap at the spacing that matches the mounting holes in the canopy. Adjust the screw so they extend 3/16" beyond the canopy.

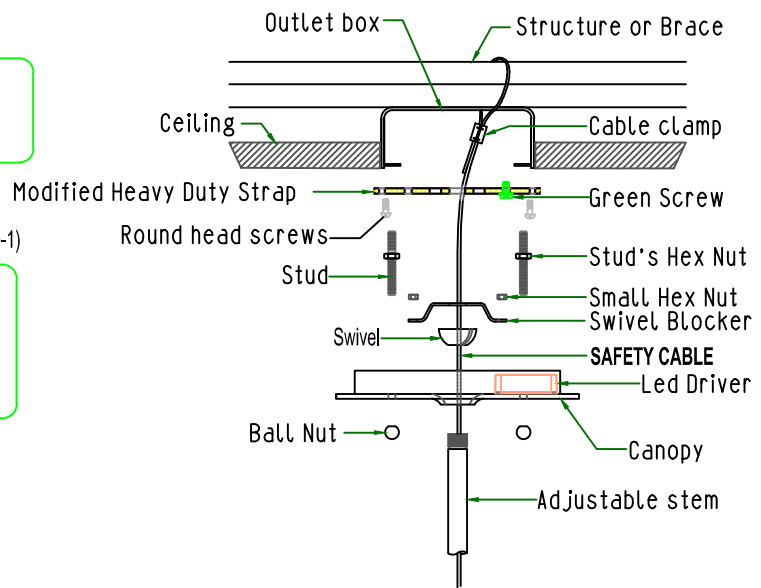

FIGURE-1

- Cut off the excess ground and fixture wire 6" beyond the canopy. Strip $\frac{1}{2}$ " of insulation from the ends of the wire. Twist the wire stands together.
- Fasten the ground wire to the green or bare copper wire in the outlet box or the green screw on the modified heavy duty strap.

WARNING

Never fasten the ground wire to the black or "hot" wire! Failure to follow this instruction could result in serious injury or death!

- Fasten the white wire from the led driver to the white wire in the outlet box. Fasten the wires together with an approved fastener (wire nut). Starting about 1" below the fastener, tightly wrap the connection with electrical tape so that the connections seals the end of the fastener. (See figure 1)

WARNING

Make sure that there is no exposed wire or strands that could cause a dangerous short circuit!

- Connect the black fixture lead to the black wire in the outlet box. Fasten the joined wires as in step 9.

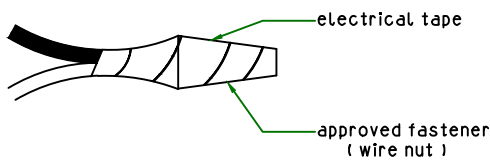

- Using the ball nut, loosely fasten the fixture to the outlet box. Adjust the orientation of the fixture and tighten the ball nut to secure the canopy to the ceiling.
- Install glasses and rods. Follow glasses and rods schedule. (See page 3 and page 4). For glass diffuser, secure it with set screw using allen wrench.
- Restore power to circuit at breaker or fuse box.

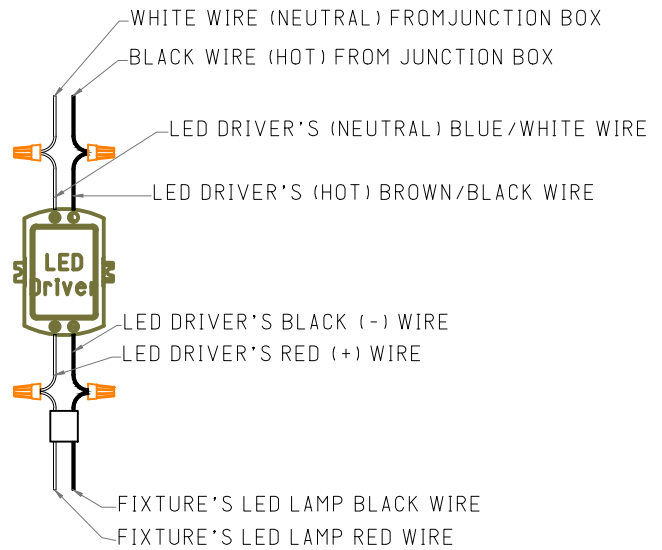

FIGURE-2

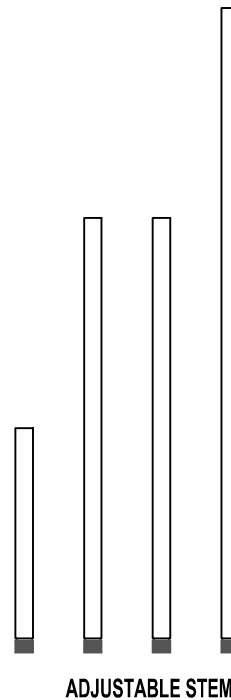
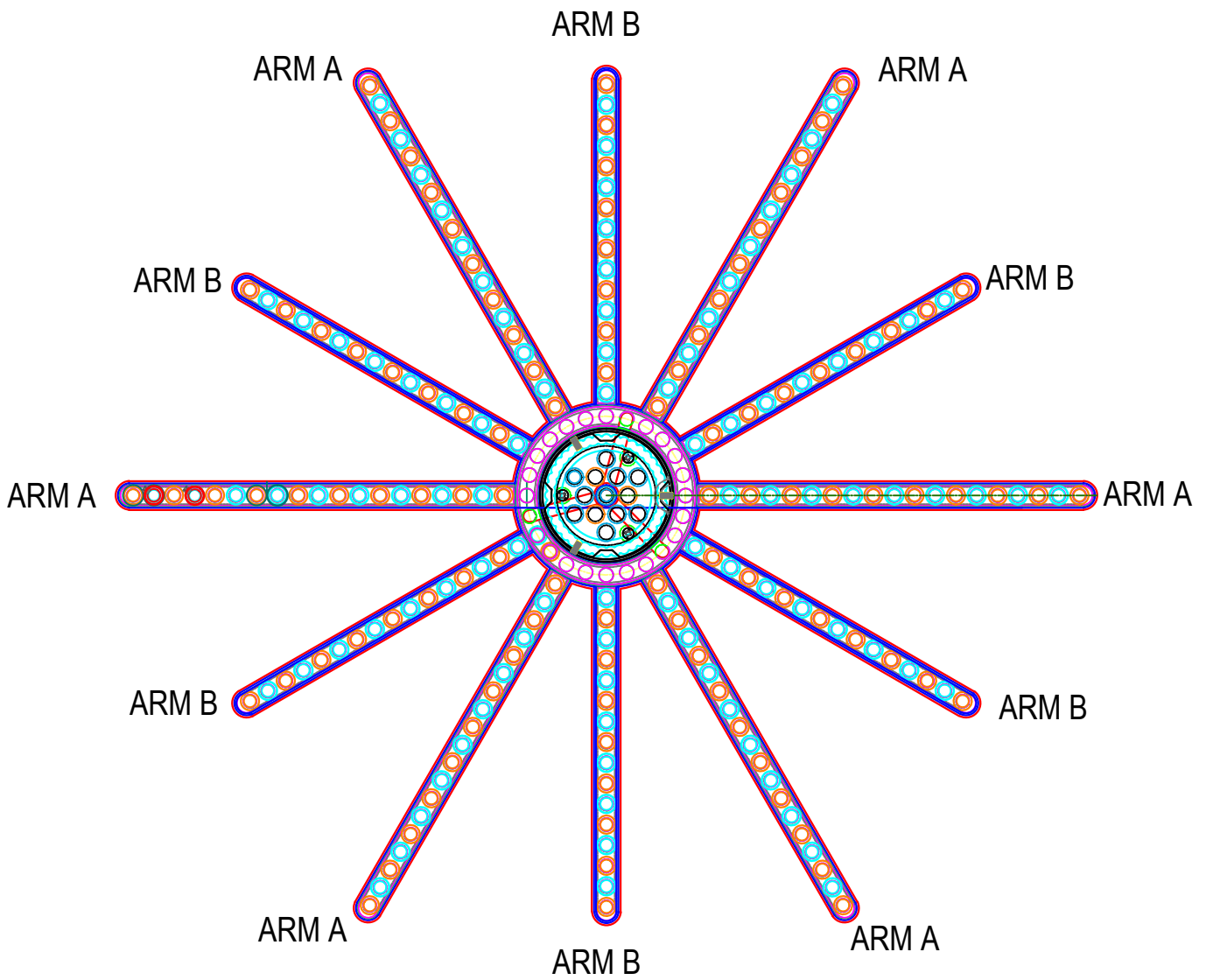
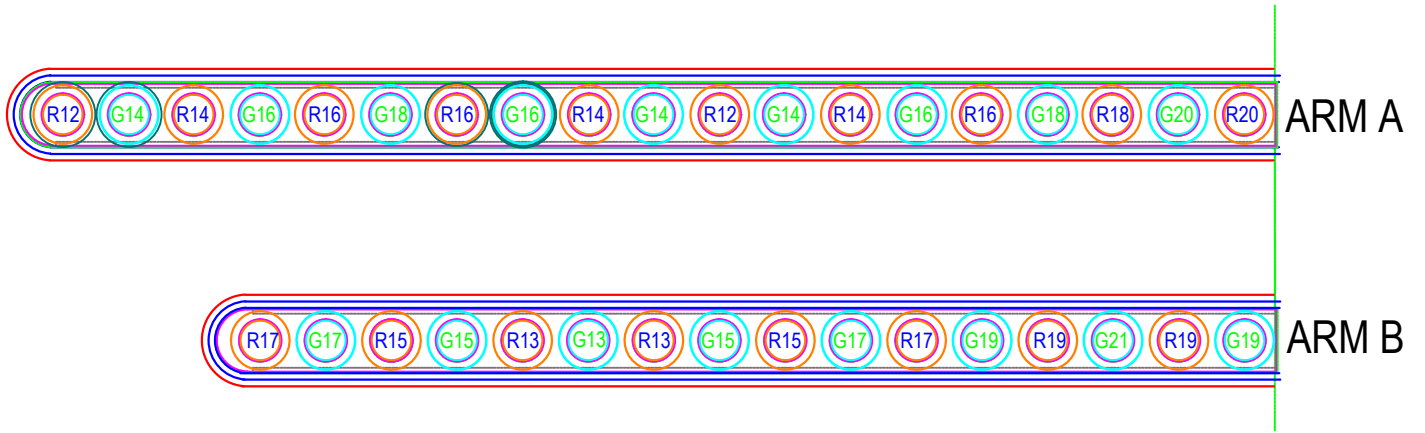
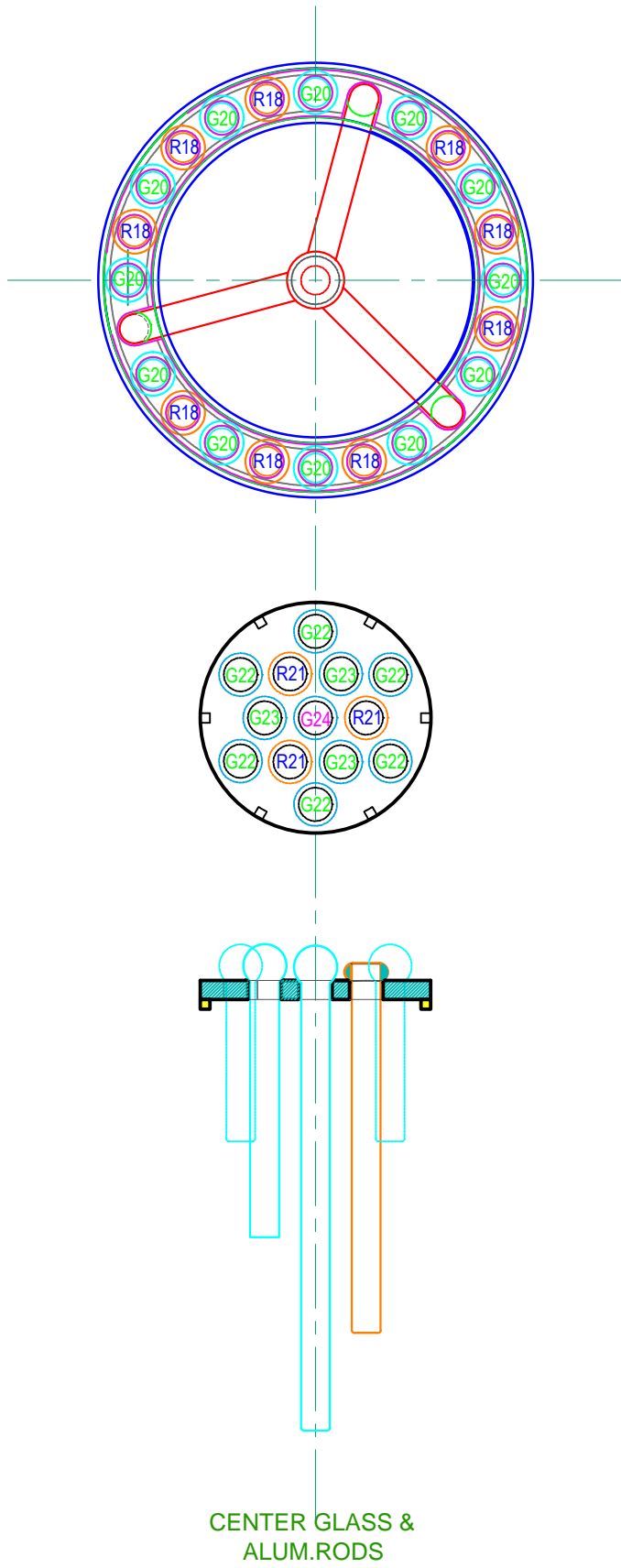
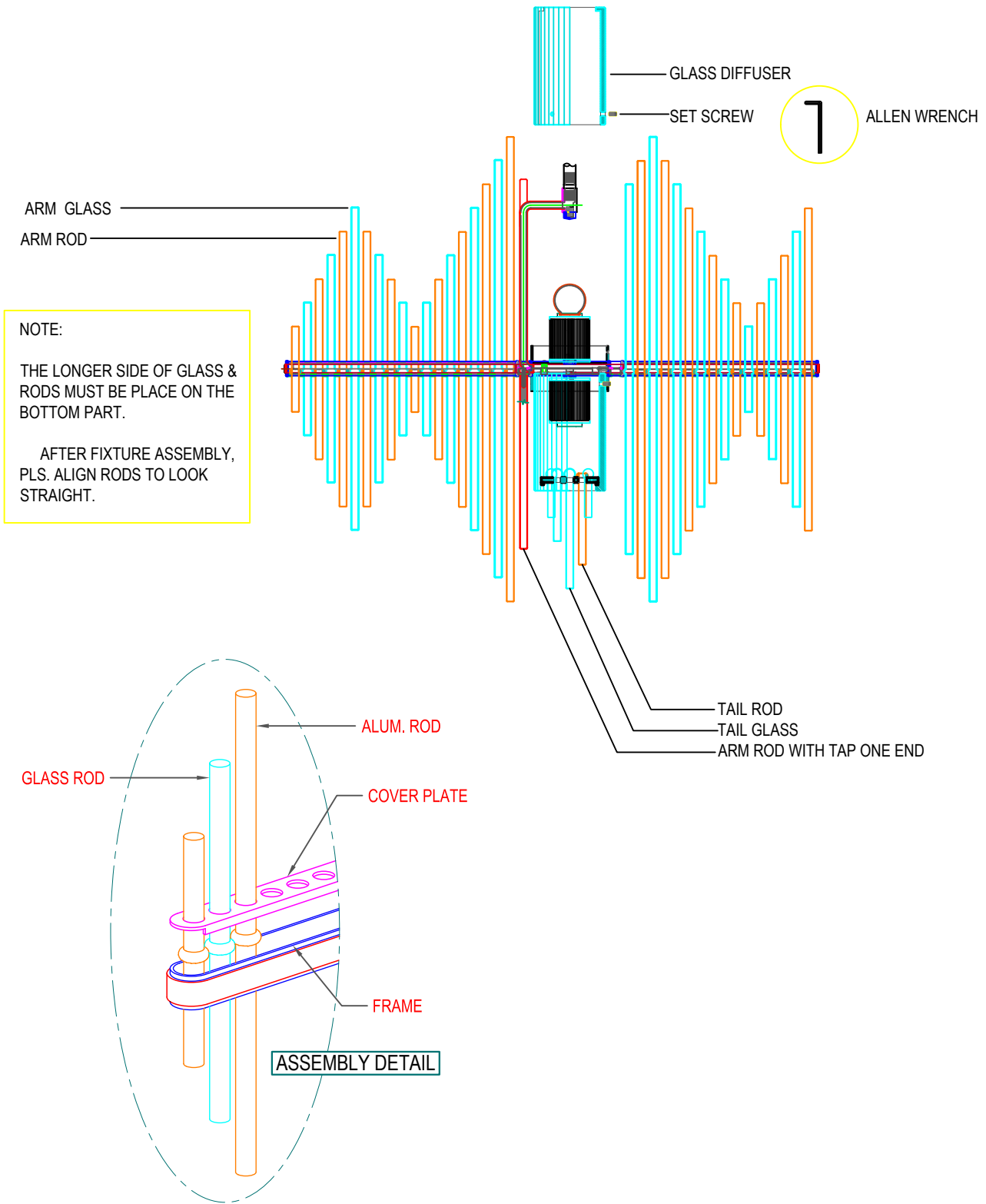

FIGURE-3





CENTER GLASS &
ALUM.RODS



GLASS RODS

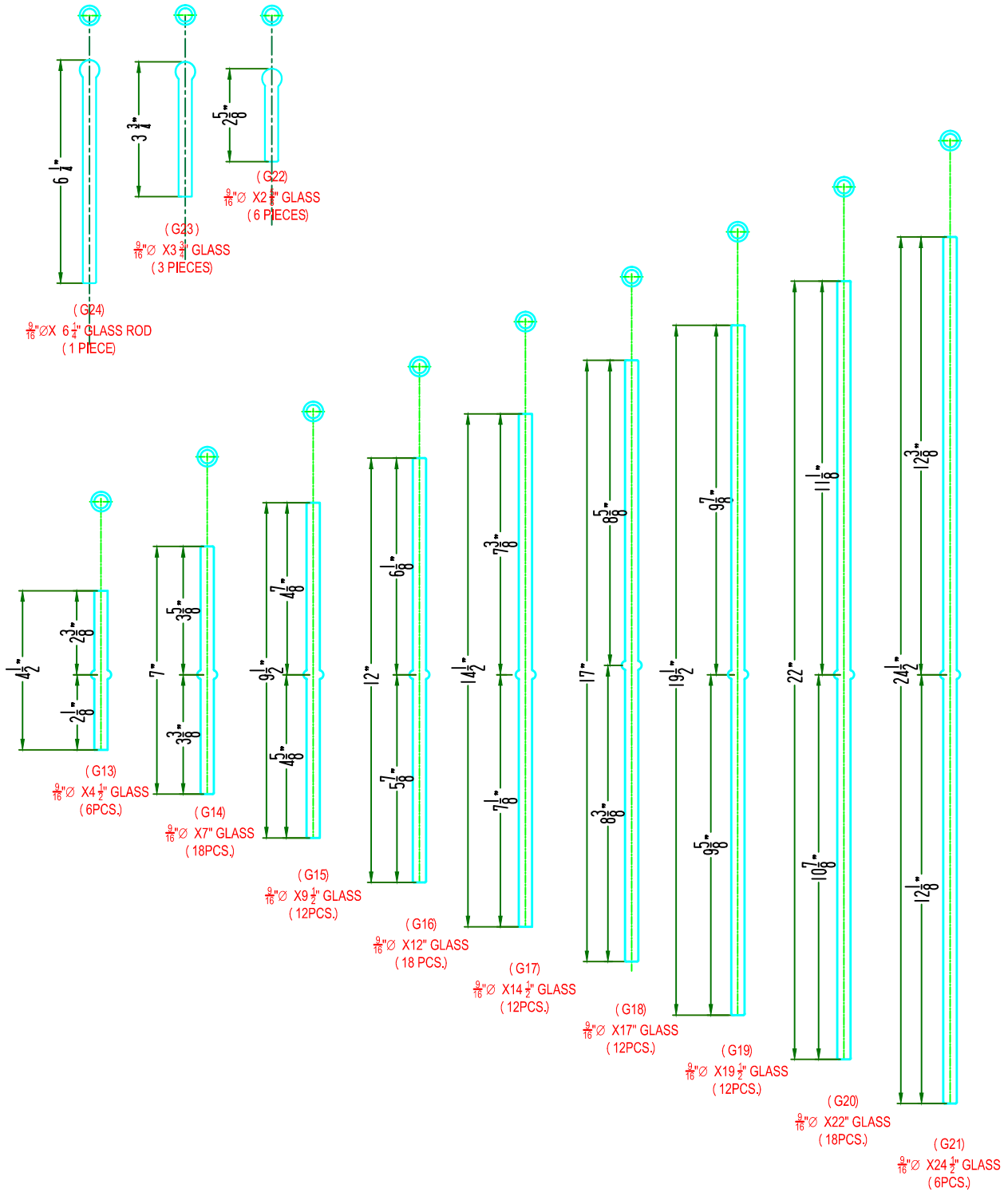

ALUM. RODS

