



WARNING

**DISCONNECT POWER BEFORE RELAMPING OR WIRING THE FIXTURE
READ ALL INSTRUCTIONS COMPLETELY BEFORE STARTING INSTALLATION.**



CAUTION

- TO AVOID THE RISK OF FIRE OR SHOCK, FIXTURE MUST BE INSTALLED IN COMPLIANCE WITH ALL APPLICABLE NATIONAL AND LOCAL ELECTRICAL/BUILDING CODES.
- INSTALLATION AND MAINTENANCE OF THIS UNIT REQUIRES AN ELECTRICIAN OR CERTIFIED FACTORY TRAINED TECHNICIAN.
- If an existing fixture is being replaced, remove it and note to which of the wires in the outlet box the fixture was attached. DO NOT SEPARATE ANY OTHER WIRES THAT MAY BE IN THE BOX. DO NOT DAMAGE THE INSULATION OF OLDER WIRING. In regular circumstances the BLACK wire will be the "Hot" lead and the WHITE wire will be the "Neutral" or "Common" lead. A GREEN or BARE COPPER wire is the "Ground". In older buildings it is always good practice to reconfirm the polarity of the wiring.

NOTICE

- The important safeguards and instructions outlined on this sheet cannot cover all possible conditions and situations that may occur. It must be understood that common sense, caution and care factors that cannot be built into any product. Caution and care must be supplied by the person(s) installing, operating and caring of this lighting fixture.
- This fixture is design to be mounted on a correctly installed standard round or octagon box or a through wiring box with a plaster frame. The box must be securely mounted to the structure of the building. The crossbar and hardware supplied should be used. Directly mounting the fixture to the outlet box may make it impossible to correctly align the fixture.

FIXTURE PREPARATION

1. Remove the fixture and parts bag(s) from the carton.

NOTICE:

**Before discarding the carton,
double check to make certain that all parts are found.**

FIXTURE INSTALLATION

1. Attach the crossbar to the outlet box. (The green screw should face out). Attach the safety cable to the structure building or brace. See figure-1.
2. Thread the hex nut onto the nipple and the nipple into the crossbar. Place the canopy over the nipple and against the ceiling. Adjust the nipple so that 1/2" of threads extend beyond the canopy. Tighten the hex nut against the crossbar. Using the cap nut, install the canopy.

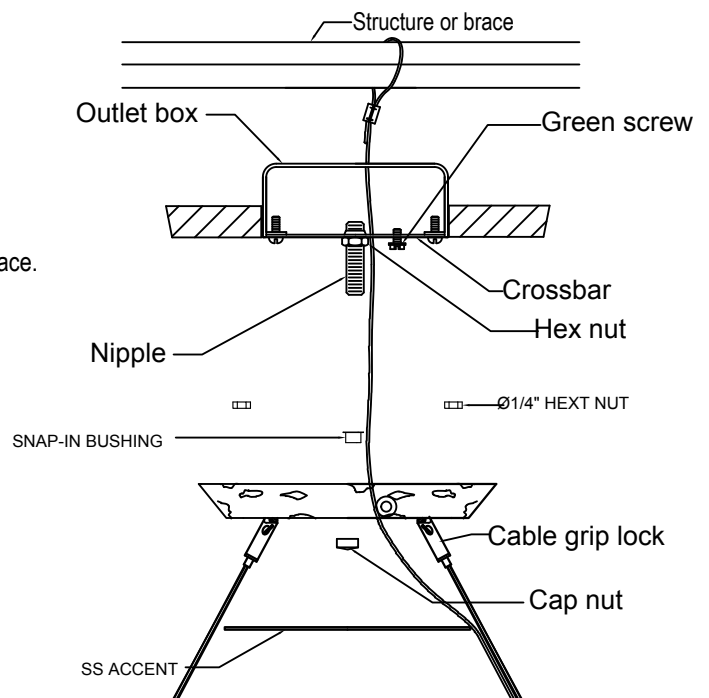

3. Adjust the cable wire and attach the cable grip lock to the canopy. Hang the fixture on the cable wire and adjust to the desired height.
4. Thread the lead wires and ground wire up through alternating links of the cable wire until the ceiling is reached.
5. Remove the fixture from the outlet box.
6. Measure 8" lead and ground wire beyond the top of the cable wire. Cut off the excess wire. Strip the insulation off the ends of the leads exposing approximately 1/2" wire. Twist the strands of wire together. Push the leads and ground wire into the canopy.
7. Fasten the ground wire to the green or bare copper wire in the outlet box (if outlet box is plastic) or to the green screw on the crossbar.

⚠ WARNING
Never fasten the ground wire to the black or "hot" wire! Failure to follow this instruction could result in serious injury or death!

8. Fasten the fixture lead with the ridge(s) to the white wire in the outlet box. Fasten the wires together with an approved fastener (wire nut). Starting about 1" below the fastener, tightly wrap the connection with electrical tape so that the connections seals the end of the fastener. (Refer to the figure above.)

⚠ WARNING
Make sure that there is no exposed wire or strands that could cause a dangerous short circuit!

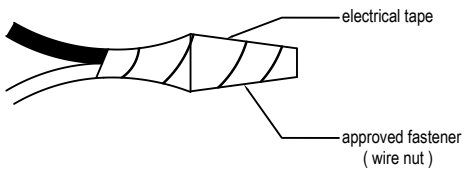

9. Connect the black fixture lead to the black wire in the outlet box. Fasten the joined wires as in step 8.
10. Using the cap nut, loosely fasten the fixture to the outlet box. Adjust the orientation of the fixture and tighten the cap nut to secure the canopy to the ceiling. Then thread the crystal ball with bobèche.
11. Install the lamps (lighting bulbs).
 NOTE: This fixture is rated for G9 20W Clear Xenon, light bulb.

⚠ WARNING
DO NOT EXCEED RECOMMENDED WATTAGE!

12. Restore power to circuit at breaker or fuse box.

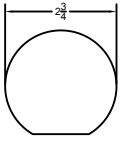
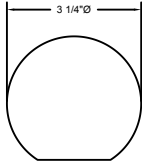
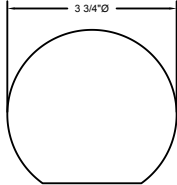
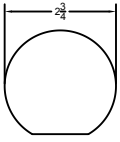
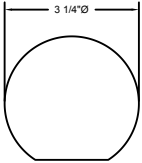
<h1>GLASS SCHEDULE</h1>				
				
9-PCS	7-PCS	8-PCS	4-PCS	4-PCS
PLATED SMOKED (SMALL) 2 3/4" Ø	PLATED SMOKED (MEDIUM) 3 1/4" Ø	PLATED SMOKED (LARGE) 3 3/4" Ø	FROSTED (SMALL) 2 3/4" Ø	FROSTED (MEDIUM) 3 1/4" Ø

